

讓家的幸福沒有極限

智能照明 · 智能安防 · 智能家電 · 免線系統 · 智能APP
無線遙控 · 語音控制 · 時序設定





CM Smart

新世代 **AI** 智能照明系統



智能系統介紹

創造無限 · 我掌控我的世界

Create unlimited · I control my World

什麼是「新世代AI智能照明系統」

What is CMsmart AI smart lighting system

- 一款顛覆傳統的**經濟與便利**安裝的系統
- 一款適用0-99歲全齡層的**人性設計**系統
- 一款簡易操作與**直覺式**的設定系統
- 一款擁有人**因照明療癒能力**的系統
- 一款結合**居家安全偵測監控防護**系統
- 一款能**遠端監控**多類型家電的控制系統
- 一款讓您全新體驗**AI 智能照明**控制系統
- 一款擁有**多年齡層**適用控制產品的系統
- 一款可**APP遠端、無線遙控、語音控制、時序設定、牆面開關**的全方位多功能系統

- A system that subverts traditional **economy and convenient** installation
- A **human design** system for all ages from 0 to 99 years old
- An easy-to-use and **intuitive setting** system
- A system for **people who have healing power**
- A combination of **home security detection and monitoring** system
- A control system that can **remotely monitor multiple** types of home appliances
- A new experience for **AI intelligent lighting** control system
- A system with **multiple age layers** for control products
- An **all-round multi-function system with app remote, wireless remote control, voice control, timing setting,** and wall switch

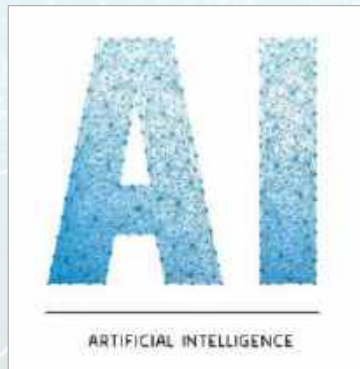



CM Smart



體現完美理念 · 超越居家極限

Reflecting the perfect concept · Beyond the limits of home

創造美好 永不妥協

Create beautiful never give up

我們深信，無論身在何處，家都是我們最棒的避風港。

家... 是一種安全感、舒適感、依賴感與歸屬感，也是家人最重要情感交流的地方，是安心的、放鬆的、有愛的、包容的、和諧的與溫暖的... 這就是療養我們身心靈的家。

透過AI 智能控制系統搭配人因照明的療愈能力與結合居家安全防護，帶給家人全方位的安全、便利、溫馨與舒適的居家環境，讓我們隨時隨地照護我們最愛的家人。

We are convinced no matter where we are, Home is our best haven.

Home is a sense of security, comfort, dependence and belonging, It is also the place, where the family's most important emotional exchanges, Relieved, relaxed, loving, inclusive, harmonious and warm, This is the home that nurtures our body and mind.

Through CMsmart AI smart control system with human-induced lighting healing ability and combined home security protection, Bring your family a safe, convenient, warm and comfortable home environment, Let us care for our favorite family anytime, anywhere.



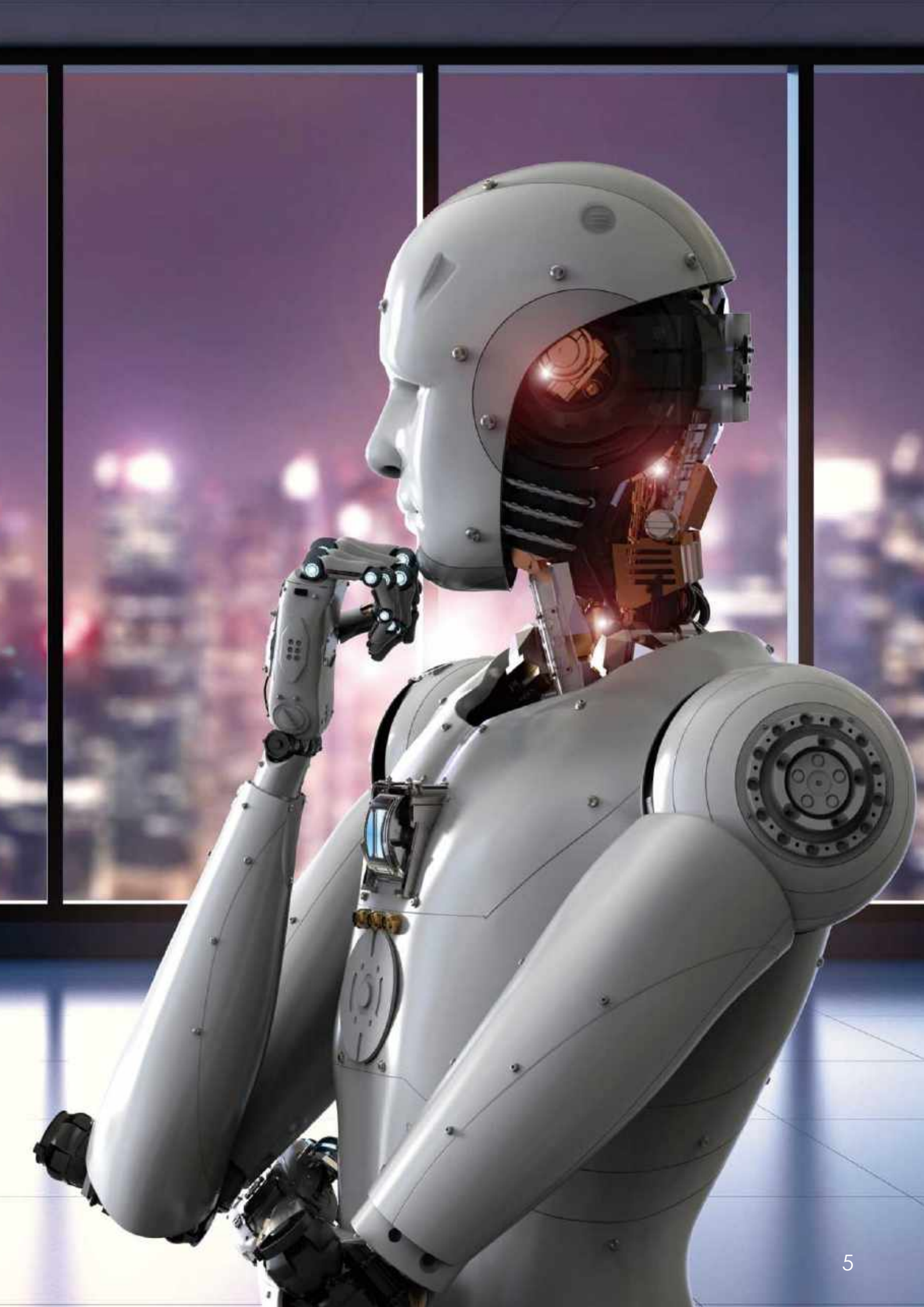



1

掌控光的療癒力

Control the healing power of light

AI 智能照明

AI Smart lighting

個人生活作息需求自動調節亮度、顏色、氣氛與光線波長，記憶個人作息設定，模仿陽光運行變化，無論是幼兒的睡眠設定或是長輩全天候作息設定，也可以為打拼事業的自己，達到調節身心作息，給您與家人最舒適的體驗與照護。

在這裡... 讓居家照明設備不只是照明，還能照護您與家人。

Personal life needs automatically adjust brightness, color, atmosphere and light wavelength, Memorizing personal work settings, Imitating sunshine changes, Whether it's a toddler's sleep setting or an elder's all-day setting, You can also adjust your mind and body for yourself., Give you and your family the most comfortable experience and care.

Let home lighting not just lighting here, Can also care for you and your family.



A

彈指一揮 遠端監控我的世界

A finger Remotely monitor my world

新世代AI情境管理，是居家智能控制的APP平台，可以依您需求，串聯設定家中智能產品與電器設備，透過Wi-Fi (網路) 遠端監控，讓您輕鬆設定家人習慣編輯情境，以個人隨心方式呈現您與家人想要的生活氛圍，隨時隨地都能靈活運用。即便是外出到遠方，都能隨時掌控居家電器產品，從最大單位的冷暖氣到最小單位的插座電源，都能遠端控制開啟或關閉，不只達到節約，還可在緊急時刻切斷電源，保護居家安全。

具備連結TuyaSmart第三方軟體可支援多方系統語音控制與智能音箱控制：

Google Assistant · Siri · Amazon Alexa · 小愛同學
天貓精靈 · 百度小度 · 騰訊小微

◆遠端遙控 ◆wifi直連 ◆手機APP ◆自訂情境

CMsmart AI situation management, is the home smart control app platform. You can set your home smart products and electrical equipment in series according to your needs. Remote monitoring via wifi allows you to easily set up your family's habits to edit situations. Present your living environment with your family in a personal way. Flexible use anytime, anywhere. Even going out to a distance. Remote control can be turned on or off not only save can also cut off the power in an emergency protecting home security. With connection to TuyaSmart third-party software, it can support multiple system languages Sound control and smart speaker control: Google Assistant · Siri · Amazon Alexa · Little Ai Tmall Elf · Baidu Xiaodu · Tencent Xiaowei

◆ Remote control ◆ WIFI direct connection ◆ Mobile app
◆ Custom situation

B

智能電源 舞動視覺 smart power Dancing vision

新世代智能電源針對不同燈具開發出合適的電源，讓居家所有燈都可一起聯動，真正滿足智能調光需求，給您全新照明體驗。

CMsmart of intelligent power supplies develop suitable power supplies for different lamps, let all the lights in the home can be linked together really meet smart dimming needs give you a new lighting experience.



臥室



客廳



戶外



- ◆ 燈具聯動 ◆ 自訂情境 ◆ 分組管理 ◆ 線性調光調色
- ◆ Lighting linkage ◆ Custom situation ◆ Group management ◆ Linear dimming



C

智能遙控器 Smart remote control

新世代智能遙控器，均無需佈線，可脫離APP而單獨實現便捷式智能控制，讓您通過光線色彩及亮度變化感受不同的氛圍，也可記憶個人喜好情境，一鍵快速變化個人設定氛圍。

CMsmart remote control easy and intelligent control can be implemented separately from the app let you experience different atmospheres through changes in light color and brightness, can also remember personal preferences, one-click rapid change of personal setting atmosphere



- ◆ 免佈線安裝 ◆ 自訂情境 ◆ 分組管理 ◆ 線性調光調色
- ◆ Free wiring installation ◆ Custom situation ◆ Group management ◆ Linear dimming

D

智能複合式面板

Intelligent composite panel

便利智慧火線技術，無須更改配線，直接替換傳統開關，多功能智慧開關設計，兼顧開燈、關燈、調光，變色功能，專利高品質智慧設計，解決單火開關多種技術難題，亦可結合CMsmart面板與Panasonic面板多類型產品搭配使用。

Convenient smart firewire technology, no need to change the wiring, directly replace the traditional switch, multi-functional smart switch design, taking into account the light on, off, dimming, color changing function, patented high-quality smart design, to solve a variety of technical problems of single-fire switch, can also be combined CMsmart panels are used in conjunction with Panasonic panel products.



◆ 傳統單火配線安裝 ◆ 多類型面板選擇 ◆ 防閃爍智慧技術 ◆ 多功能智能設計

◆ Traditional single-fire wiring installation ◆ Multi-type panel selection ◆ Anti-flicker smart technology ◆ Multifunctional intelligent design

E

智能聯動情境開關

Smart linkage context switch

時尚與科技便利的展現，智能便利科技一鍵聯動控制，加入時尚面板設計，單一指令就完成個人喜好情境氛圍，從燈光氣氛與燈光顏色到家電3C設備與窗簾，都能一鍵指令完成，讓生活中燈光美學與居家設備都在您的一指控制間。

Fashion and technology convenience,intelligent convenience technology one-button linkage control,join the stylish panel design,a single instruction completes the personal preference situation from lighting and lighting colors to home appliances 3C equipment and curtains can be completed with one click let the lighting aesthetics and home equipment in your life be in your fingertips.



◆ 安靜無聲 ◆ 靈敏控制 ◆ 燈具聯動 ◆ 時尚科技 ◆ 3C家電控制

◆ Quiet and silent ◆ Sensitive control ◆ Lighting linkage ◆ Fashion technology ◆ 3C appliance control



2 全方位防護 對家人全方位的愛

All-round protection for family love

智能安防

Smart security

我們深信家人是我們一生最重要的人，如果家中還有幼兒與長者，更是需要費心照顧，家人的居家安全就是一門重要的功課。

因此，新世代AI智能照明系統結合雲端攝影機、人體紅外線感應器、門窗磁感應器、指紋安全鎖、煙霧警報器、瓦斯偵測器與多功能連動聲光警報器等，各類型安全防護偵測產品，組成聯動智能防安系統，期望在全方位的防護中提供高水準的居家安防品質，滿足您對家人的完美呵護需求。

We are convinced that family is the most important person in our lives if there are children and elders in the family more need to take care of family safety at home is an important lesson.

Therefore the Cmsmart AI smart lighting system combines cloud camera, PIR sensor, door and window magnetic sensor, fingerprint security lock, smoke alarm, gas detector and multi-function linked sound and light alarm various types of security detection products Synthetic intelligent anti-security system expect to provide a high level of home security in a full range of protection meet your perfect care needs for your family.





A

遠程監看攝影機

Remote monitoring camera

新世代智能系統如果處於離家模式或睡眠模式，攝影鏡頭會自動開啓為防護狀態，全屋即馬上進入監控中，若出現火災或異常活動等情況，自動警報鳴笛並同一時間發信息到手機。

CMsmart AI smart systems if they are in home mode or sleep mode the photographic lens will automatically open to the protective state the whole house will immediately enter the monitoring in the event of fire or abnormal activity Automatic alarm whistle and send messages to the phone at the same time.

- ◆ 遠端監控 ◆ wifi直連 ◆ 手機APP ◆ 語音對講
- ◆ Remote control ◆ WIFI direct connection ◆ Mobile app ◆ Voice intercom





B

人體紅外線感應 PIR senso

不常走動的區域、小角落、茶水間或倉庫，有了人體紅外線感測器，馬上偵測並聯動開啓燈光照明，節能又可提醒防護，智能感應器具備APP設定功能，可選擇同時聯動燈具或警報器等多項產品，也可設定調整時序感應與開關時間。

Infrequent areas, small corners, pantry or warehouse with PIR sensor Immediately detect parallel opening to turn on lighting energy saving and reminder protection smart sensor with APP setting function choose to link multiple lamps or alarms at the same time can also be set to adjust timing sensing and on/off time.

- ◆ 人體感應 ◆ 人來即亮 ◆ 隨意放置 ◆ 時序設定 ◆ 聯動智能
- ◆ PIR sensor ◆ People come bright ◆ Feel free to place ◆ Timing setting ◆ Linkage intelligence

C

煙霧與瓦斯警報器 Smoke and gas alarm

煙霧濃度過高或瓦斯洩漏時，警報器自動感應警報，並同一時間發信息到手機與聲光警報器。

Alarm automatic sensing alarm, simultaneously send messages to mobile phones and sound and light alarms

- ◆ 煙霧/瓦斯偵測 ◆ 偵測警報
- ◆ 連線手機 ◆ APP提醒
- ◆ Smoke/gas detection ◆ Detection alert
- ◆ Connected mobile phone ◆ APP reminder





D

指紋安全鎖 **Fingerprint lock**

無論是指紋、密碼、鑰匙、電子卡片與智能APP開門時都會自動於您的手機上生成開門紀錄門禁管理一目了然，當然如果親愛的家人或訪客來訪您也可以遠端發送限時密碼或一次性密碼供訪客使用。

Whether it's fingerprints, passwords, keys, e-cards and smart apps Automatically generate an open door record on your mobile phone when you open the door access control at a glance of course, if dear family or visitors visit you can also send a time-limited password or a one-time password to the visitor.

- ◆ 開門記錄 ◆ 雲端管理 ◆ 遠端授權
- ◆ Opening record ◆ Cloud management ◆ Remote authorization
- ◆ 連線手機 ◆ 管理便利 ◆ 安全加密
- ◆ Connected mobile phone ◆ Management convenience ◆ Secure encryption



指紋

鑰匙



密碼

電子卡片

智能APP





3 家電安全升級

Home appliance security upgrade

智能家電

Smart Appliances

新世代智能家電遙控機，能學習複製傳統紅外線電器（如冷氣、電視、家庭影音、電扇... 等無線遙控設備），能輕鬆讓居家電器和系統連結，同時可搭配智能窗簾、智能插座及智能開關，輕鬆連結居家所有用電，從大型冰箱、冷暖機... 到小型插座與延長線，都能隨時遠程監控，同時也可時間設定達到安全防護管理與節能管理。

AI 智能機器人，擁有多種語言辨識，在居家是個智能的科技管家，在家人心中是情感交流的朋友，提供陪伴、語言對話、播放音樂、查詢新聞與氣象，也是語音控制系統的AI 管家。

CMsmart AI home appliance remote control machine can learn to copy traditional infrared appliances (such as air-conditioning, TV, home audio and video, electric fans and other wireless remote control devices) can easily connect home appliances and systems at the same time, it can be matched with smart curtains, smart sockets and smart switches. Easily connect all your homes with electricity from large refrigerators, warmers to small outlets and extension cords Can be monitored remotely at any time at the same time, time can be set to achieve safety protection management and energy management.

AI intelligent robot multilingual recognition at home is a smart technology housekeeper a friend of emotional communication in the hearts of my provide companionship, language conversation, play music, check news and weather also the ai housekeeper of the voice control system.

A

智能窗簾

Smart curtain

透過APP、遙控器或無源開關，不用下床，輕鬆調控窗簾開合出國或無人在家時，也可遠端隨時開關窗簾，營造氣氛，防範宵小。

Via APP, remote control or passive switch easy to control curtain opening without going out of bed remotely switch curtains at any time when going abroad or when no one is at home create an atmosphere to guard against thieves.

- ◆ 遠端遙控 ◆ 自訂情境
- ◆ Remote control ◆ Custom situation
- ◆ 語音控制 ◆ 定時開關
- ◆ voice control ◆ Set open close

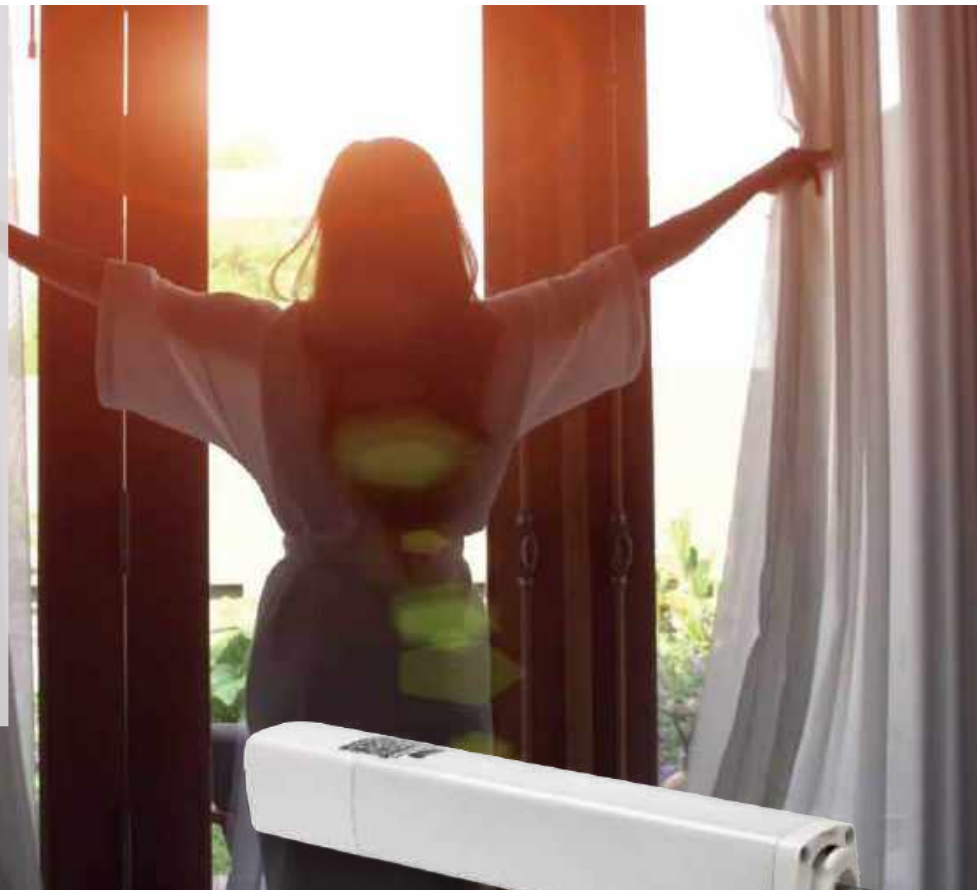
**B**

智能開關與插座

Smart switch and socket

我們利用聰明低成本的方式讓顧客能從更低的價格中受益，只要加上智能開關或插座，所有家電立即實現遠端遙控與定時開關的功能。

We use smart and low-cost ways to enable customers to benefit from lower prices. Just add a smart switch or socket. All appliances immediately implement remote control and timer switch functions.



- ◆ 佈線簡單 ◆ 定時開關 ◆ 遠端控制 ◆ 時序設定
- ◆ Simple wiring ◆ Set open close ◆ Remote control ◆ Timing setting



C

AI 機器人管家 AI robot butler

人工智慧AI管家，能用多種語言自動辨識對話，能自動播放音樂，說故事講笑話，可陪伴幼兒及老人，還可以查詢氣象與新聞，是聯動控制家電的超級管家。支援Google Assistant · Siri · Amazon Alexa · 小愛同學 · 天貓精靈 · 百度小度 · 騰訊小微

Artificial intelligence ai housekeeper ability to automatically identify conversations in multiple languages can automatically play music telling stories and telling jokes can accompany young children and the elderly You can also check weather and news. Is the super housekeeper of linkage control appliances. Support Google Assistant · Siri · Amazon Alexa · Xiao Ai · Tmall Elf · Baidu Xiaodu · Tencent Xiaowei

- ◆ 遠端遙控 ◆ wifi直連 ◆ 直接對話 ◆ 生活助手
- ◆ Remote control ◆ WIFI direct connection ◆ Direct dialogue ◆ Life assistant



產品證書



※智能燈具為訂製品※

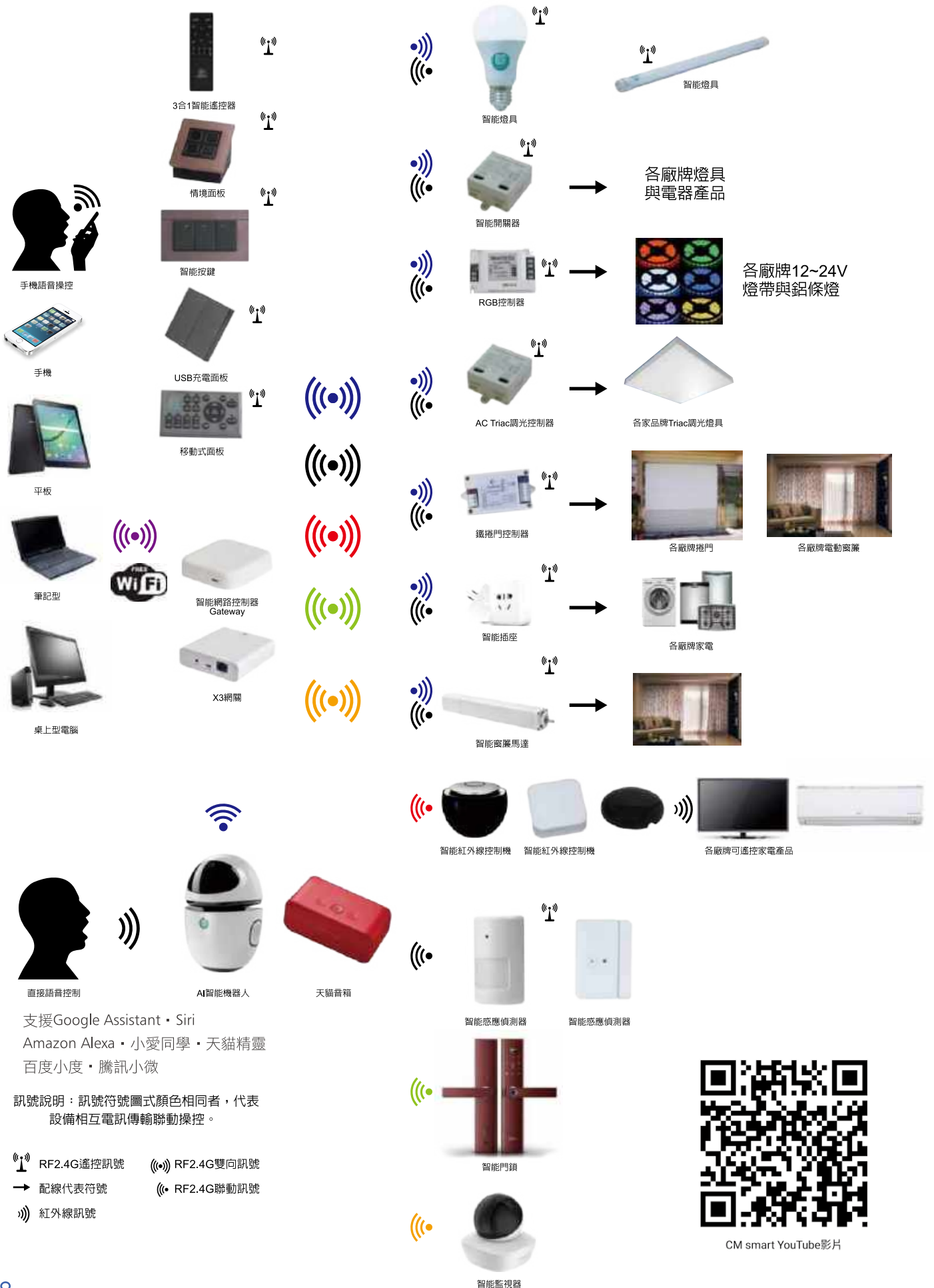

PRO Gateway

PRO Gateway and Smart Situation Panel



PRO網關 CM-AP02-1



CM-APX3-1

(全方位訊號支援：Sig Mesh 藍芽+2.4g+ZigBee)

智能網路控制器(網關)Gateway PRO版

Intelligent network controller (gateway) Gateway PRO version

額定電壓 Rated voltage	安卓 5V 1A 90V-240V AC
APP系統平台 APP system platform	IOS蘋果 8.0以上/Andriod安卓4.0以上
通訊協定 Communication protocol	Wi-Fi IEEE 802.11 b/g/n2.4GFSK Mesh
輸入功率 Input powerData rate	3W MAX
Wi-Fi發射功率 Wi-Fi transmit power	+14dBm~20dBm
控制距離 Control distance	30m(無障礙空間)
節點組網方式 Node networking mode	星型、樹型
控制節點數量 Number of control nodes	128點(MAX)
安裝方式 Installation method	5V/Micro USB
情境記憶 Contextual memory	32組情境
區域群組 Area group	32組區域
支援語音系統 Support voice system	支援Google Assistant.Siri Amazon Alexa、小愛音箱、天貓精靈 百度小度、騰訊小微

藍色燈號狀態說明：

- 快閃：網路控制器處於配網狀態
處理方式：使用APP添加網關
- 沒亮：網路控制器未連接路由器
處理方式：長按復位鍵至藍燈快閃，使用APP添加網關
- 慢閃(1秒1次)：網路控制器連接不上伺服器
處理方式：A.確保路由器有網路，並嘗試重新啓路由器
B.重新啓動網關，待網關重新連接上伺服器

※解除帳號綁定：長按復位鍵，燈號快閃即可重新配對

強制解除：長按復位鍵20秒，重新送電，長按復位鍵至藍燈綠燈快閃即可配對。

(解除綁定須重新設定請留意)

※智能設備與網關小知識：

- App可添加網關無上限，須留意家中使用的路由器wifi節點限制。
- 1組網關可記憶32組區域，32組情境模式，不同網關設備不支援設計情境聯動。
- 智能紅外線機與監視器，是直連wifi不需透過網關，添加數量依據家中使用的路由器wifi節點限制，網路信號傳輸速度會影響產品同步性。
- 單一智能設備可同時設定8組無線遙控+1組網關。
- 一個網關可添加128節點(設備)，節點(設備)不含直連遙控設備，智能紅外線機，監視器與智能音箱，其他設備均涵蓋在APP節點內。
- 單一帳號可添加設備數量是依據網關添加數量為上限。



智能App控制教學



PRO網路控制器

智能複合式開關

Intelligent compound switch



CM-BPS1-01



CM-BPS1-02



CM-BPS1-03

基本參數：

智能開關（單火線）

無線連接：2.4g Mesh 有效距離>15M

配線方式：單火線

輸入：AC100-240V, 50/60Hz

L單向取電迴路輸入Max 300W

其他迴路Max 1000W/迴路

工作溫度：-10°C ~ 50°C

工作濕度：5%~95%RH,無冷凝

面板尺寸：127X76mm

開關壽命：>5萬次

適用燈具：CMsmart全系列智能燈具，搭配智能開關適用所有燈具

外殼材質：防火阻燃 PC

適用面板：CMsmart & Panasonic國際牌開關面板

操作與設置

- 1.安裝前請先開啓開關背面的電源開關，面板上的夜間指示藍燈亮起
- 2.進行開關與燈具的對碼(參閱遙控器對碼方式)
- 3.迴路對碼完成後將開關嵌入面板上，並參照配置圖方式配置
- 4.動作方式：

開 燈：迴路開關 上開關位置 點按為開啓燈具

關 燈：迴路開關 下開關位置 點按為關閉燈具

亮度調亮：迴路開關 上開關位置 長按為亮度調亮

亮度調暗：迴路開關 下開關位置 長按為亮度調暗

白光/黃光/暖白光/小夜燈：迴路開關 上開關位置連續點按 按壓間隔時間約1秒

補助說明：1.燈具經開關調整後會記憶當前狀態

2.當迴路上燈具光線或色溫不同步時：先將迴路關燈後再開啓，連續點按上開關位置直到同步為止



USB充電式面板

全方位防護 對家人全方位的愛

智能複合式開關

Intelligent compound switch

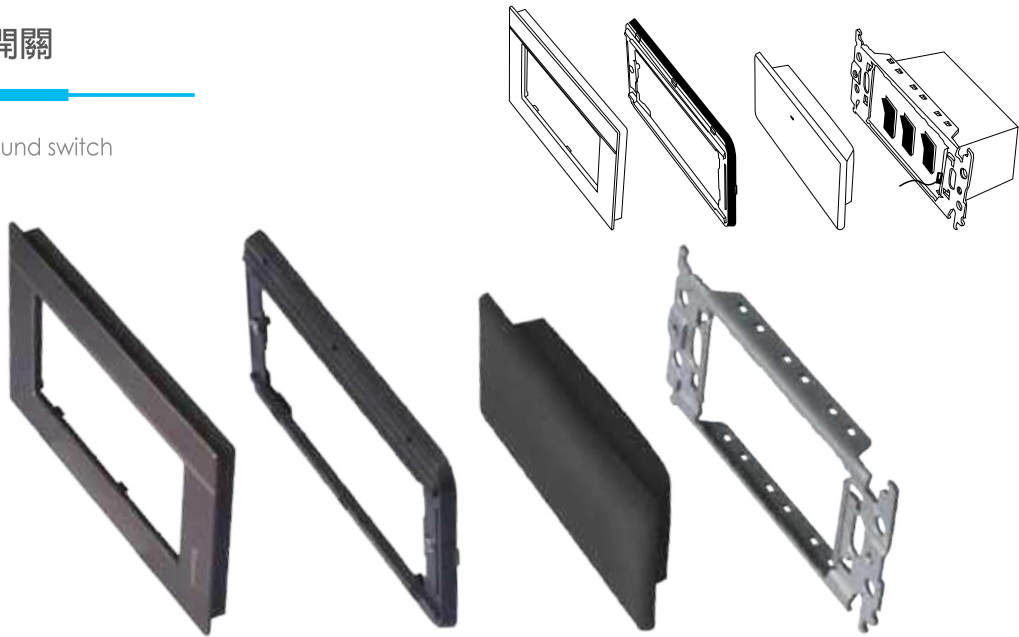

本產品需要搭配CMsmart燈具或智能開關使用。

採用CMsmart模塊的單火版智能開關直聯版本，推出的高品質單火智能開關，攻克了市面上現有常見單火開關多種技術難點，解決了單火線微亮閃爍和不穩定易燒壞的難題。

產品特色：

告別單火閃爍：採用先進的單火線技術，不必外接“防閃爍”配件。

安裝無須改線：直接安裝替換傳統開關，無須重新佈線。

兼營傳統雙控及多控：CMsmart壁面智能開關可實現多方式不在拘泥於只能傳統雙切開關方式。

品質穩定可靠：無須功率晶體及繼電器做為迴路導通方式，負載更大無開關接點壽命問題，無LED燈開啓瞬間的大電流衝擊。

注意事項：

請按規範操作，以免引發觸電安全事故及電器火災。

- 1.因涉電安裝，務必確保操作人員持有電工類作業資質並採取必要的斷電、絕緣防護措施。
- 2.安裝過程中涉及強電操作，應由專業電工進行安裝，安裝前確認線路處於斷電狀態。
- 3.在安裝接線操作前，請確保已經完全斷開操作位置的線路電源，切勿帶電操作。
- 4.安裝開關時，請不要濕手或站在潮濕的地面操作。
- 5.請勿超出產品所標示的最大功率負載使用。

配線方式：

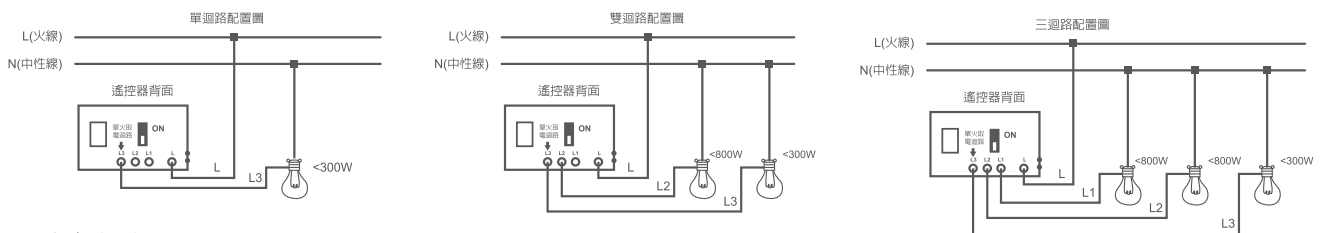

注意事項：

請按規範操作，以免引發觸電安全事故及電氣火災

- 1.因涉電安裝，務必確保操作人員持有電工類作業資質並採取必要的斷電、絕緣防護措施。
- 2.安裝過程中涉及強電操作，不建議個人安裝，應由專業電工進行安裝，安裝前確認線路處於斷電狀態。

移動式面板

Mobile panel

移動式四迴路四情境面板

Mobile four-circuit four-situation panel



CM-FPP1-1

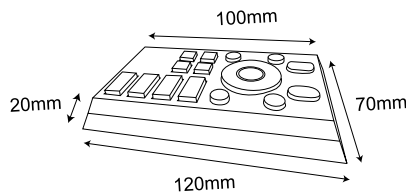

工作頻段 Working frequency	2.400 GHz~2.483 GHz
調製解調方式 Modem	GFSK
發射功率 Transmit power	4dBm
接收靈敏度 Receiving sensitivity	-88 dBm
數據率 Data rate	2Mbps
有效直線傳輸距離 Effective straight line transmission distance	>15M
模組工作電壓 Module operating voltage	2.5-3.3V
動態工作電流 Dynamic operating current	15~30mA
電器規格 Electrical specifications	5V / Micro USB
對碼接收模組數量 Number of code receiving modules	無限制
底座額定電壓 Rated voltage of base	AC 90~240V
底座輸出電壓 Base output voltage	5V 0.35A

※遙控操作說明：

驅動與負載燈具，在接通電源的瞬間(5秒內)續按3下 **ALL ON** 或分組控制器1之ON  該燈將"快閃3下"完成本次對頻。

※同時購買2組以上對頻設定：

第1組燈如同上述動作對頻完成後，請先將其燈具斷電，開啓要對頻的燈具如上述動作，依序對頻。

※分組控制設定：

將驅動與負載燈具，電源連接正常完成後，選定需要分組控制的燈，接通電源的瞬間(5秒內)按對應ON鍵

 或  該燈將"快閃3下"確認配對與分組成功，重複以上步驟直到將所有欲分組的燈分組。

※情境設定：

將場景調整為預設亮度與色溫，再將A~D鍵 ，長按3秒、場景燈光將會快閃一下，代表已完成設定，

※清除對碼：

將驅動與負載燈具，再接通電源的瞬間(5秒內)續按5下 **ALL OFF** 該燈將"快閃3下"完成清除對頻。

如有分組控制清除2、3組依上述按依序2、3組OFF鍵  即可。

※按鍵介紹：

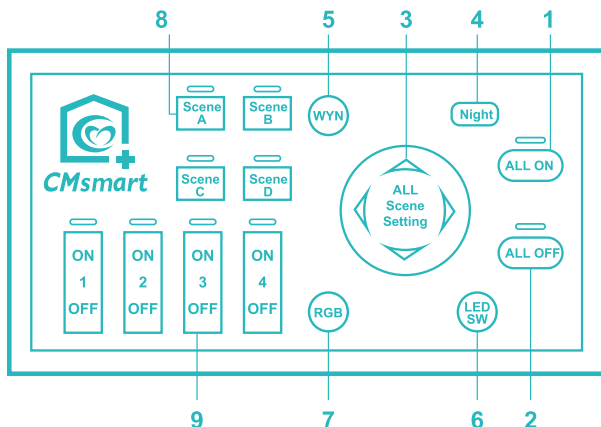

1. 總迴路(開/喚醒)
2. 總迴路關
3. 調光調色
4. 5%模式
5. 白光·黃光·中性光
6. 按鍵顯示燈(開/關)
7. 全彩燈(循環/定色)
8. 情境模式
9. 迴路(開/關/喚醒)



移動式面板

智能遙控器與控制面板

Smart remote control and control panel



CM-RF02-1

3合1智能遙控器

3-in-1 system remote control

工作頻段 Working frequency	2.400 GHz~2.483 GHz
調製解調方式 Modem	GFSK
發射功率 Transmit power	4dBm
接收靈敏度 Receiving sensitivity	-88 dBm
數據率 Data rate	2Mbps
有效直線傳輸距離 Effective straight line transmission distance	>15m
模組工作電壓 Module operating voltage	2.5-3.3V
動態工作電流 Dynamic operating current	15~30mA
電池規格 Battery specification	4號電池X2
對碼接收模組數量 Number of code receiving modules	無限制

※遙控操作說明：

驅動與負載燈具，再接通電源的瞬間(5秒內)續按3下 **ALL ON** 或分組控制器1之 **ON**  該燈將"快閃3下"完成本次對頻。

※同時購買2組以上對頻設定：

第1組燈如上述動作對頻完成後，請先將其燈具斷電，開啓要對頻的燈具如上述動作，依序對頻。

※分組控制設定：

將驅動與負載燈具，電源連接正常完成後，選定需要分組控制的燈，接通電源的瞬間(5秒內)按對應ON鍵

 或  該燈將"快閃3下"確認配對與分組成功，重複以上步驟直到將所有欲分組的燈分組。

※情境設定：

將場景調整為預設亮度與色溫，再將人物鍵  長按3秒、場景燈光將會快閃一下，代表已完成設定，

※清除對碼：

將驅動與負載燈具，再接通電源的瞬間(5秒內)續按5下 **ALL OFF** 該燈將"快閃3下"完成清除對頻。

如有分組控制清除2、3組依上述按依序2、3組OFF鍵  即可。

※按鍵介紹：

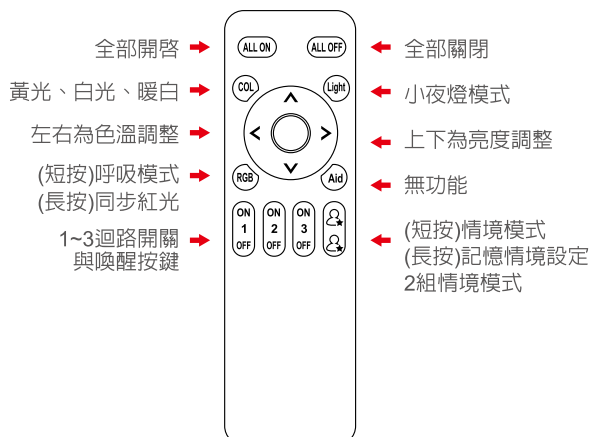

三合一遙控器

情境面板

Context panel

科技與時尚情境面板



CM-AISB-04

智能聯動情境開關 Intelligent linkage scene switch

夜光辨識 Luminous Recognition	模式辨識 Pattern Recognition	情境記憶 Pisodic Memory	使用電壓 Operating Voltage	通訊協議 Communication Protocol	顏色 colour
有	有	4鍵	AC 100-240V	Lemesh 2.4G	黑

※需搭配網關APP設定



智能情境開關



A1系列為科技銀
B1系列為時尚金

建議開孔尺寸/面板尺寸

單聯開孔尺寸：55X60mm / 86X86mm

二聯開孔尺寸：141X60mm / 172X86mm

三聯開孔尺寸：227X60mm / 258X86mm

四聯開孔尺寸：313X60mm / 344X86mm

桌上型情境開關



CM-AIST-B1



CM-AIST-A1

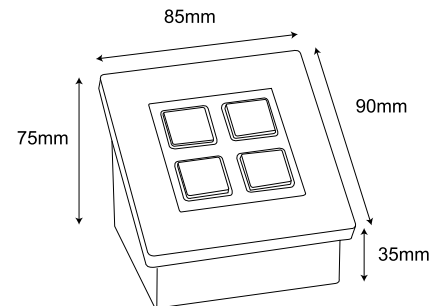

智能燈帶、窗簾、捲門、AC調光控制器

Smart curtain, roll door controller

12~24V燈帶控制器 12~24V light strip controller



單色軟帶燈：CM-AICP-T1(單迴路)
 黃白軟帶燈：CM-AICP-T2(雙迴路)
 RGB軟帶燈：CM-AICP-T3(三迴路)
 RGB+黃白軟帶燈：CM-AICP-T5(5迴路)

額定功率 Wattage rating	輸入電壓 Input voltage	可控迴路 Controllable loop	工作溫度 Operating temperature	控制距離 Distance control
200W	DC12~24V	單雙迴路(黃.白) 三迴路(R.G.B) 五迴路(R.G.B黃.白)	-10~50°C	直線30米

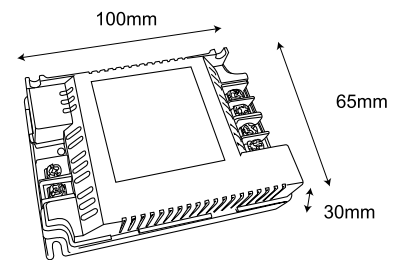

窗簾機、捲門控制器

Curtain, roll door controller



CM-AIOP-F1

工作電壓 operating voltage	接點迴路 Contact loop	接點容量 Contact capacity	輸出模式 Output mode
100~240V	2迴路	<10A	可調接點1S 2S 3S 長閉

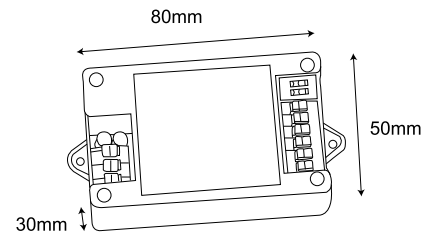

智能AC調光控制器

Intelligent AC controller

無線TRIAC單組遙控調光系列



CM-AIAC-D1

工作電壓 operating voltage	適用負載 Applicable load	額定功率 rated power	調光方式 Dimming method	通訊方式 Communication Protocol
依據負載使用 (支援範圍100~240V)	TRIAC型	100W	PWM無段	RF2.4G

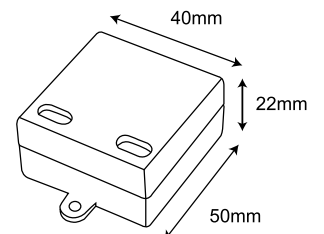
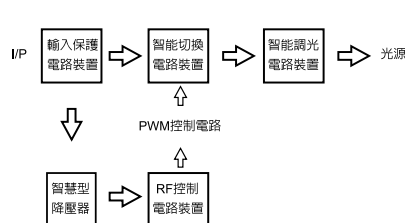
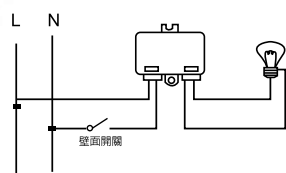

智能燈帶控制器配線

Smart light strip controller wiring



規格參數：
 輸入電壓：直流10~36V
 輸出範圍：5~100%
 調光方式：PWM 2KHz/PWM 16KHz
 無線式：RF 2.4G
 有效距離：>15M
 智能遙控操作說明



燈帶控制器教學

設定與解除說明：

●對碼與分組：

將控制器與電源正確連接，接通電源的瞬間(5秒鐘內)點按分組迴路開關ON鍵三下。
 該燈將“閃爍3下確認配對與分組成功。重複以上步驟即可完成燈帶分組，可參考遙控器設定。

●清除對碼：

接通電源的瞬間(5秒鐘內)連續按五下ALL OFF該燈將閃爍3下完成本次清碼。

※ 12V負載需搭配12V電源，24V負載需搭配24V電源，電源輸出功率(W)需大於負載功率。

單色燈帶配線：



雙色燈帶配線：



RGB燈帶配線：



RGB+黃白燈帶配線：



無線智能偵測器 Wireless smart sensor



CM-AIPR-01

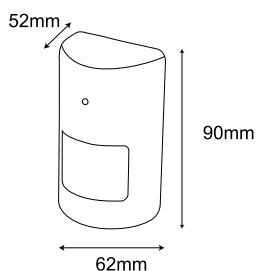

PIR紅外線感應器 PIR infrared body sensor

電池規格 Battery specification	控制頻率 Control frequency	操控距離 Control distance	設定方式 Setting method	工作濕度 Working humidity	電源指示燈 Power Indicato
3號電池X2	2.4GHz	>6M(無障礙空間)	直聯式&互聯式	0-61%RH	LED 紅燈



PIR感應器教學

智能門磁感應器 Intelligent door sensor



CM-AIDM-01

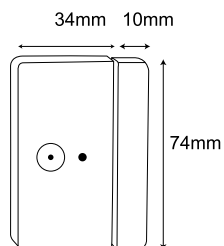

控制頻率 Control frequency	發射頻率 Transmitting frequency	額定電壓 Rated voltage	電池規格 Battery specification	控制距離 Distance control	本體材質 Body material
2.4G GFSK Mesh	6dBm	DC 3.3V	鈕扣電池 CR2032	≥ 30m (無障礙空間)	PC



門磁感應器教學

滿足您對家人的完美呵護需求



AI 智慧管家 smart in life

智能紅外線控制機 Intelligent infrared controller

CM-AIEI-S08
64.7X20mm

CM-AIEI-01

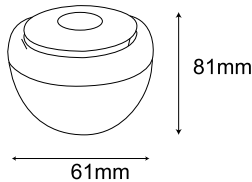
CM-AIEI-03
限使用安卓系統

81mm

61mm

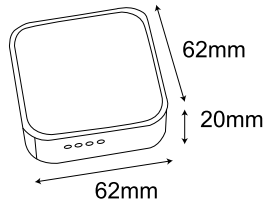

62mm

20mm

62mm



紅外線控制器-上篇



紅外線控制器-下篇

工作電壓 operating voltage	控制距離 Control distance	通訊協議 Protocol	工作溫度 Working humidity	淨重 Working humidity	接收角度 Power Indicato
5VDC1.0A~ 2.0A(USB供電) Micro USB	<10M	通訊協議 WIFI/4G	-10°C~+50°C	116g	180°

智能窗簾機 Smart curtain machine



產品型號 Product number	適用尺寸 Size
CM-AICM-2.2	2.16米以下
CM-AICM-3.2	2.16~3.16米以下
CM-AICM-4.2	3.16~4.16米以下
CM-AICM-5.2	4.16~5.16米以下
CM-AICM-6.2	5.16~6.16米以下
CM-AICM-7.2	6.16~7.16米以下
CM-AICM-8.2	7.16~8.16米以下



窗簾遙控與App設定教學

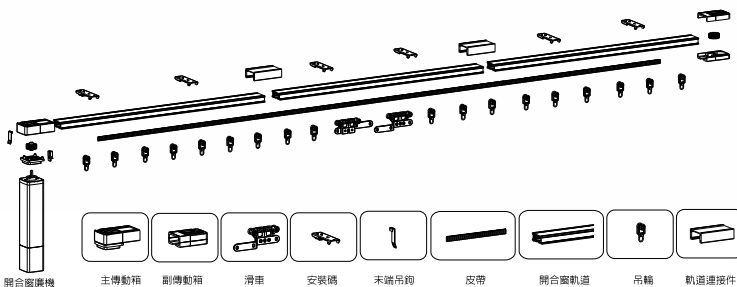

開合窗簾機 主傳動箱 副傳動箱 滑車 安裝碼 末端吊鉤 皮帶 閉合窗軌道 吊輪 軌道連接件

※窗簾設定

- 1.對碼/解碼：首先將電機斷電5秒後送電，使用遙控器點按開按鍵3次對碼(3秒內完成動作)，反之按關5次(解碼)。
- 2.行程設定：首先將電機斷電5秒後送電，使用遙控器5秒內按開...電機行走到底停止後再按關...電機行走到底停止後設定完成。
- 3.電機方向調整：遙控器與電機對碼後，連續按5次夜燈按鍵，在連續按5次遙控器開按鍵！
- 4.重置行程：長按馬達底座復位按鍵三秒，紅燈亮起以後，鬆開復位按鍵，直到紅燈熄滅後，完成清除行程。

實現家庭窗簾的智能開關

手拉啟動功能：通電狀態下，用手往一方向輕輕拉動窗簾10公分左右，窗簾就會自動行走。

停電手拉功能：斷電情況下，可以像普通窗簾一樣輕鬆手動打開或關閉窗簾。

遇阻停止功能：當電機運行過程中，遇到阻礙時，電機自動停止，保護系統。

自動設定記憶行程：斷電後，電機每次上電，都可自行尋找打開和關閉的行程點。

多種控制方式：根據需要，可選擇無線遙控，有線開關多種控制方式。

軌道自由拼接：DIY 設計，軌道自由拼接。

Realizing the intelligent opening of home curtains

Hand-start function: Under the power-on state, gently pull the curtain about 10 cm in one direction, the curtain will automatically walk.

Power-off hand function: In the case of power failure, you can manually open or close the curtain as easily as ordinary curtains.

Blocking stop function: When the motor is running, when the obstacle is encountered, the motor stops automatically, and the protection system

Automatically set the memory stroke: After the power is turned off, the motor can find the opening and closing points by itself every time the motor is

powered on.

A variety of control methods: according to needs, you can choose wireless remote control, wired switch, multiple control methods.

Free track stitching: DIY design, free track stitching.

智能電控與插座 Intelligent electronic control and socket



CM-AINO-500W

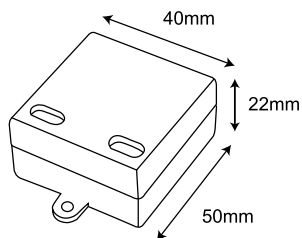

開關控制器教學

智能開關控制器

Intelligent switch controller

工作電壓 operating voltage	AC:90V~264V 50/60Hz
負載功率 Load power	< 500W
負載電流 Load current	< 5A (220V)
工作溫度 Working humidity	-10°C~60°C
淨重 net weight	60g
通訊協議 Protocol	lemesh2.4G
外殼材質 shell material	PC



CM-AIST-1000W

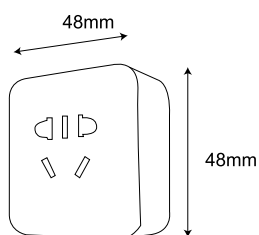

智能插座教學

移動智能插座

工作電壓 operating voltage	AC85V~265V
負載功率 Load power	< 1000W
負載電流 Load current	< 5A(220V)
工作溫度 Working humidity	-10°C~+60°C
淨重 net weight	60g
通訊協議 Protocol	lemesh2.4G
外殼材質 shell material	PC

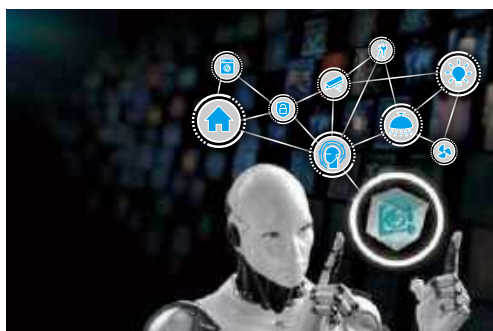

家電安全升級

智能雙色、全彩球泡燈 Smart two-color, full-color bulb



E14智能蠟燭燈系列



尖清
AIC14-B5T

額定電壓 Rated voltage	額定瓦數 Rated wattage	色溫範圍 Color temperature range	調光範圍 Dimming range	光通量 Luminous flux
90V-240V	5W	2700~6500K	5%~100%	560Lm

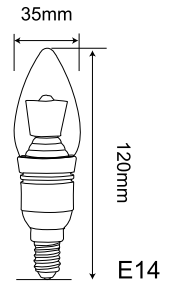

- 特性：
- 無需添加訊號線，安裝簡便
 - 智能線性無段式調光調色
 - 支援智慧分組管理設定
 - 支援多類型智能產品聯動
 - 支援時序控制設定
 - 同時支援RF無線遙控、遠端APP與AI智能語音控制
 - 高演色性更接近自然光

- characteristic：
- Easy to install without adding signal lines
 - Intelligent linear stepless dimming
 - Support smart group management settings
 - Support multi-type smart product linkage
 - Support timing control settings
 - Support RF wireless remote control, APP and AI intelligent voice control

智能雙色球泡燈



AIB27-10T



6500K-6000K-5500K-4000K-3500K-2700K

額定電壓 Rated voltage	額定瓦數 Rated wattage	色溫範圍 Color temperature range	調光範圍 Dimming range	演色系 Color rendering
90V-240V	10W	2700~6500K	5%~100%	RA>95

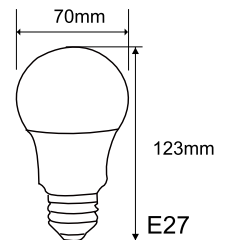

- 特性：
- 無需添加訊號線，安裝簡便
 - 智能線性無段式調光調色
 - 支援智慧分組管理設定
 - 支援多類型智能產品聯動
 - 支援時序控制設定
 - 同時支援RF無線遙控、遠端APP與AI智能語音控制
 - 高演色性更接近自然光

- characteristic：
- Easy to install without adding signal lines
 - Intelligent linear stepless dimming
 - Support smart group management settings
 - Support multi-type smart product linkage
 - Support timing control settings
 - Support RF wireless remote control, APP and AI intelligent voice control

智能全彩球泡燈



AIB27-06R

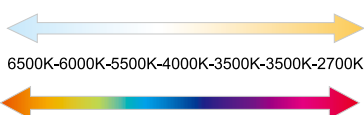

6500K-6000K-5500K-4000K-3500K-2700K

R.G.B全彩變化

額定電壓 Rated voltage	額定瓦數 Rated wattage	色溫範圍 Color temperature range	調光範圍 Dimming range	光通量 Luminous flux
90V-240V	6W	全彩	5%~100%	600Lm

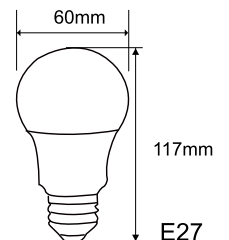

- 特性：
- 無需添加訊號線，安裝簡便
 - 智能線性無段式調光調色
 - 支援智慧分組管理設定
 - 支援多類型智能產品聯動
 - 支援時序控制設定
 - 同時支援RF無線遙控、遠端APP與AI智能語音控制
 - 具備全彩RGB與黃白調色調光

- characteristic：
- Easy to install without adding signal lines
 - Intelligent linear stepless dimming
 - Support smart group management settings
 - Support multi-type smart product linkage
 - Support timing control settings
 - Support RF wireless remote control, APP and AI intelligent voice control

智能雙色串接燈

Intelligent two-color stringing light



2尺串接燈 9W

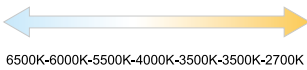

6500K-6000K-5500K-4000K-3500K-2700K

產品型號 Product number	額定電壓 Rated voltage	色溫範圍 Color temperature range	調光範圍 Dimming range	光通量 Luminous flux
T5LW-AI10	100V-240V	白光6000K	5%~100%	1000Lm
T5LA-AI10	100V-240V	暖白4000K	5%~100%	1000Lm
T5LY-AI10	100V-240V	黃光3000K	5%~100%	1000Lm
T5LT-AI10	100V-240V	2700~6500K	5%~100%	1000Lm

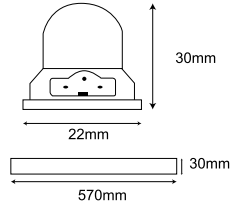

■ 特性：

- 無需添加訊號線，安裝簡便
- 智能線性無段式調光調色
- 支援智慧分組管理設定
- 支援多類型智能產品聯動
- 支援時序控制設定
- 同時支援RF無線遙控、遠端APP與AI智能語音控制

■ characteristic：

- Easy to install without adding signal lines
- Intelligent linear stepless dimming
- Support smart group management settings
- Support multi-type smart product linkage
- Support timing control settings
- Support RF wireless remote control, APP and AI intelligent voice control

3尺串接燈 13W

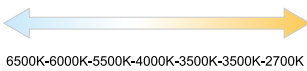

6500K-6000K-5500K-4000K-3500K-2700K

產品型號 Product number	額定電壓 Rated voltage	色溫範圍 Color temperature range	調光範圍 Dimming range	光通量 Luminous flux
T5LW-AI13	100V-240V	白光6000K	5%~100%	1300Lm
T5LA-AI13	100V-240V	暖白4000K	5%~100%	1300Lm
T5LY-AI13	100V-240V	黃光3000K	5%~100%	1300Lm
T5LT-AI13	100V-240V	2700~6500K	5%~100%	1300Lm

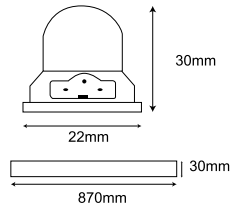

■ 特性：

- 無需添加訊號線，安裝簡便
- 智能線性無段式調光調色
- 支援智慧分組管理設定
- 支援多類型智能產品聯動
- 支援時序控制設定
- 同時支援RF無線遙控、遠端APP與AI智能語音控制

■ characteristic：

- Easy to install without adding signal lines
- Intelligent linear stepless dimming
- Support smart group management settings
- Support multi-type smart product linkage
- Support timing control settings
- Support RF wireless remote control, APP and AI intelligent voice control

4尺串接燈 18W

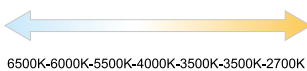

6500K-6000K-5500K-4000K-3500K-2700K

產品型號 Product number	額定電壓 Rated voltage	色溫範圍 Color temperature range	調光範圍 Dimming range	光通量 Luminous flux
T5LW-AI20	100V-240V	白光6000K	5%~100%	2000Lm
T5LA-AI20	100V-240V	暖白4000K	5%~100%	2000Lm
T5LY-AI20	100V-240V	黃光3000K	5%~100%	2000Lm
T5LT-AI20	100V-240V	2700~6500K	5%~100%	2000Lm

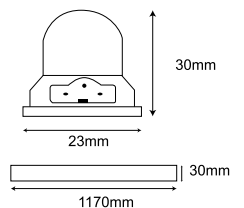

■ 特性：

- 無需添加訊號線，安裝簡便
- 智能線性無段式調光調色
- 支援智慧分組管理設定
- 支援多類型智能產品聯動
- 支援時序控制設定
- 同時支援RF無線遙控、遠端APP與AI智能語音控制

■ characteristic：

- Easy to install without adding signal lines
- Intelligent linear stepless dimming
- Support smart group management settings
- Support multi-type smart product linkage
- Support timing control settings
- Support RF wireless remote control, APP and AI intelligent voice control

LED一體式串接燈具

LED all-in-one series lighting



高演色性 保護眼睛 無藍光危害 安全環保



LED T5一體式串接燈

產品型號 Product number	規格 Specification	額定電壓 Rated current	消耗瓦數 Wattage consumption	色溫範圍 Color temperature range	流明 Lumen	尺寸 size
T5LW-04W	1尺4W	110V/220V	4W	白光6000K	499 Lm	296X22X29
T5LW-04A	1尺4W	110V/220V	4W	暖白4000K	490 Lm	296X22X29
T5LW-04Y	1尺4W	110V/220V	4W	黃光3000K	485 Lm	296X22X29
T5LW-08W	2尺8W	110V/220V	8W	白光6000K	825 Lm	570x22x29
T5LW-08A	2尺8W	110V/220V	8W	暖白4000K	810 Lm	570x22x29
T5LW-08Y	2尺8W	110V/220V	8W	黃光3000K	790 Lm	570x22x29
T5LW-12W	3尺12W	110V/220V	12W	白光6000K	1286 Lm	875x22x29
T5LW-12A	3尺12W	110V/220V	12W	暖白4000K	1250 Lm	875x22x29
T5LW-12Y	3尺12W	110V/220V	12W	黃光3000K	1220 Lm	875x22x29
T5LW-16W	4尺16W	110V/220V	16W	白光6000K	1590 Lm	1170x22x29
T5LW-16A	4尺16W	110V/220V	16W	暖白4000K	1560 Lm	1170x22x29
T5LW-16Y	4尺16W	110V/220V	16W	黃光3000K	1540 Lm	1170x22x29

■ 特性：

- 綠色環保設計理念，不含鉛、汞有害金屬，二氧化碳排放量減少85%。
- 光線無紫外線放射。
- 流明維持率大於90%。
- 內含驅動器，容易安裝。
- 最多可串接燈具數量為7具。
- 無斷光設計，光線更柔和。
- 光源壽命比螢光燈管長，維護成本低。
- 燈具材質：乳白PC罩，防火塑料本體。

■ Characteristic :

- Green and environmentally friendly design concept, free of lead and mercury harmful metals, Reduce carbon dioxide emissions by 85%.
- The light does not emit ultraviolet rays.
- The lumen maintenance rate is greater than 90%.
- Contains the driver, easy to install.
- Up to 7 lamps can be connected in series.
- With no interrupted light design, the light is softer.
- The life of the light source is longer than that of the fluorescent tube, and the maintenance cost is low.
- Lamp material: milky white PC cover, aluminum extruded body to dissipate heat.

智能雙色T8燈管 Intelligent two-color T8 tube



2尺 智能LED T8 鋁塑燈管9W

產品型號 Product number	額定電壓 Rated voltage	色溫範圍 Color temperature range	調光範圍 Dimming range	光通量 Luminous flux
T8LL-AI10TH	90V-240V	2700~6500K	5%~100%	1000Lm

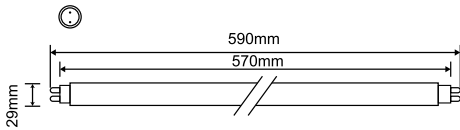
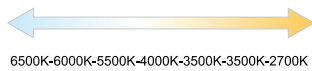

- 特性：
 - 無需添加訊號線，安裝簡便
 - 智能線性無段式調光調色
 - 支援智慧分組管理設定
 - 支援多類型智能產品聯動
 - 支援時序控制設定
 - 同時支援RF無線遙控、遠端APP與AI智能語音控制
- 材質：鋁塑

- characteristic :
 - Easy to install without adding signal lines
 - Intelligent linear stepless dimming
 - Support smart group management settings
 - Support multi-type smart product linkage
 - Support timing control settings
 - Support RF wireless remote control, APP and AI intelligent voice control
- Material: aluminum



4尺 智能LED T8 鋁塑燈管18W

產品型號 Product number	額定電壓 Rated voltage	色溫範圍 Color temperature range	調光範圍 Dimming range	光通量 Luminous flux
T8LL-AI20TH	90V-240V	2700~6500K	5%~100%	2000Lm

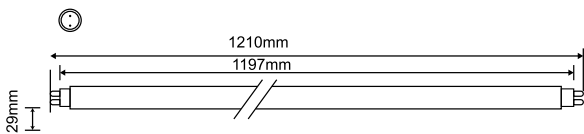
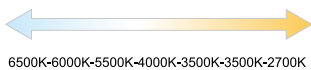

- 特性：
 - 無需添加訊號線，安裝簡便
 - 智能線性無段式調光調色
 - 支援智慧分組管理設定
 - 支援多類型智能產品聯動
 - 支援時序控制設定
 - 同時支援RF無線遙控、遠端APP與AI智能語音控制
- 材質：鋁塑

- characteristic :
 - Easy to install without adding signal lines
 - Intelligent linear stepless dimming
 - Support smart group management settings
 - Support multi-type smart product linkage
 - Support timing control settings
 - Support RF wireless remote control, APP and AI intelligent voice control
- Material: aluminum

CNS BSMI 認證型 LED T8玻璃燈管150lm/W



CNS certified high luminous efficiency LED T8 glass tube 150lm/W

150lm/W

高光效LED T8玻璃燈管2尺7W/4尺14W

產品型號 Product number	額定電壓 Rated voltage	色溫範圍 Color temperature range	調光範圍 Dimming range	光通量 Luminous flux
T8LL-07WH	90V-240V	白光6000K	無調光	1050Lm
T8LL-14WH	90V-240V			2100Lm

■ 特性：

- CNS認證，符合國家安全標準
- 150lm/W高光效節能，更省電
- 無藍光危害、紅外線及UV輻射
- 高演色性
- 無頻閃、無噪音設計
- 不含汞及危險物質
- 高光效能

■ 材質：玻璃

■ characteristic：

- CNS certification, in line with national safety standards
- 150lm/W high luminous efficiency and energy saving, more power saving
- No blue light hazard, infrared and UV radiation
- High color rendering
- No flicker, no noise design
- No mercury and hazardous substances
- High light efficiency

■ Material: glass

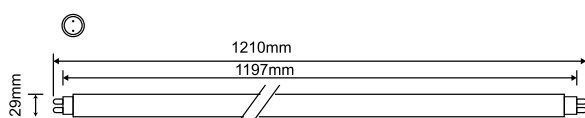
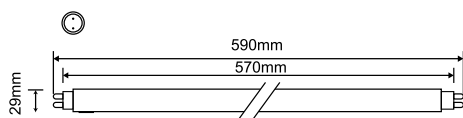

2尺/4尺LED T8玻璃燈管9W/18W

產品型號 Product number	額定電壓 Rated voltage	色溫範圍 Color temperature range	調光範圍 Dimming range	光通量 Luminous flux
T8LL-09WH	90V-240V	白光6000K	無調光	900Lm
T8LL-09AH	90V-240V	暖白4000K		900Lm
T8LL-09YH	90V-240V	黃光3000K		900Lm
T8LL-18WH	90V-240V	白光6000K		1800Lm
T8LL-18AH	90V-240V	暖白4000K		1800Lm
T8LL-18YH	90V-240V	黃光3000K		1800Lm

■ 特性：

- 無藍光危害、紅外線及UV輻射
- 高演色性
- 無頻閃、無噪音設計
- 不含汞及危險物質
- 高光效能、節能省電
- 耐用、壽命長

■ 材質：玻璃

■ characteristic：

- No blue light hazard, infrared and UV radiation
- High color rendering
- No flicker, no noise design
- No mercury and hazardous substances
- High light efficiency, energy saving and power saving
- Durable and long life

■ Material: glass

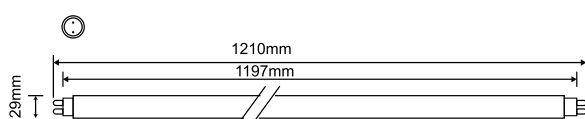
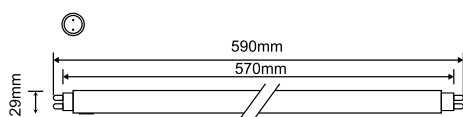

智能雙色崁燈 Intelligent two-color xenon lam



10W



6500K~6000K-5500K-4000K-3500K-3000K-2700K

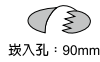

嵌入孔：90mm

產品型號 Product number	額定電壓 Rated voltage	色溫範圍 Color temperature range	調光範圍 Dimming range	光通量 Luminous flux
CMAI-PW10	110V-220V	白光6000K	5%~100%	1000Lm
CMAI-PY10	110V-220V	黃光3000K	5%~100%	960Lm
CMAI-PA10	110V-220V	暖白4000K	5%~100%	950Lm
CMAI-PT10	110V-220V	2700K~6500K	5%~100%	1000Lm

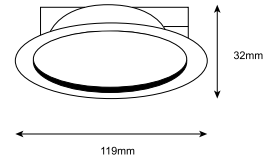

- 特性：
- 無需添加訊號線，安裝簡便
 - 智能線性無段式調光調色
 - 支援智慧分組管理設定
 - 支援多類型智能產品聯動
 - 支援時序控制設定
 - 同時支援RF無線遙控、遠端APP與AI智能語音控制

- characteristic：
- Easy to install without adding signal lines
 - Intelligent linear stepless dimming
 - Support smart group management settings
 - Support multi-type smart product linkage
 - Support timing control settings
 - Support RF wireless remote control, APP and AI intelligent voice control

15W



6500K~6000K-5500K-4000K-3500K-3000K-2700K



嵌入孔：150mm

產品型號 Product number	額定電壓 Rated voltage	色溫範圍 Color temperature range	調光範圍 Dimming range	光通量 Luminous flux
CMAI-PW15	110V-220V	白光6000K	5%~100%	1500Lm
CMAI-PY15	110V-220V	黃光3000K	5%~100%	1350Lm
CMAI-PA15	110V-220V	暖白4000K	5%~100%	1350Lm
CMAI-PT15	110V-220V	2700K~6500K	5%~100%	1500Lm

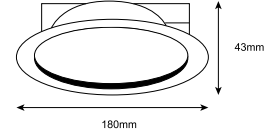

- 特性：
- 無需添加訊號線，安裝簡便
 - 智能線性無段式調光調色
 - 支援智慧分組管理設定
 - 支援多類型智能產品聯動
 - 支援時序控制設定
 - 同時支援RF無線遙控、遠端APP與AI智能語音控制

- characteristic：
- Easy to install without adding signal lines
 - Intelligent linear stepless dimming
 - Support smart group management settings
 - Support multi-type smart product linkage
 - Support timing control settings
 - Support RF wireless remote control, APP and AI intelligent voice control

150W 智能調光天井燈

150W Smart monochrome patio light



產品型號 Product number	額定電壓 Rated voltage	色溫範圍 Color temperature range	調光範圍 Dimming range	光通量 Luminous flux
CMAI-HL-150	110V-220V	白光6000K	20%~100%	20000Lm

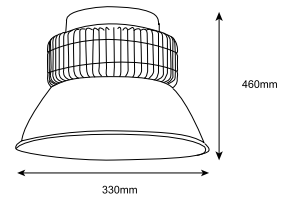

- 特性：
- 無需添加訊號線，安裝簡便
 - 智能線性無段式調光
 - 支援智慧分組管理設定
 - 支援多類型智能產品聯動
 - 支援時序控制設定
 - 同時支援RF無線遙控、遠端APP與AI智能語音控制

- characteristic：
- Easy to install without adding signal lines
 - Intelligent linear stepless dimming
 - Support smart group management settings
 - Support multi-type smart product linkage
 - Support timing control settings
 - Support RF wireless remote control, APP and AI intelligent voice control

新型LED燈管 New LED tube



高演色性 保護眼睛 RS1038 無藍光危害 安全環保 節能標準

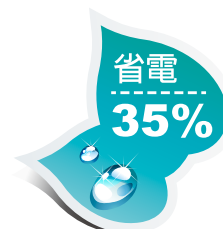

LT5燈管 新型LED燈管
相容T5電子式安定器
可與T5螢光燈管並存免改線路

LED T5燈管

產品型號 Product number	規格 Specification	額定電流 Rated current	色溫範圍 Color temperature range	流明 Lumen	發光效率 Luminous efficiency	尺寸 size
LT5-09W	2尺9W	0.17A	白光6000K	950 Lm	105Lm/W	G5-563.2X15
LT5-09A	2尺9W	0.17A	暖白4000K	950 Lm	105Lm/W	G5-563.2X15
LT5-09Y	2尺9W	0.17A	黃光3000K	900 Lm	100Lm/W	G5-563.2X15
LT5-18W	4尺18W	0.17A	白光6000K	2000 Lm	111Lm/W	G5-1163.2X15
LT5-18A	4尺18W	0.17A	暖白4000K	1950 Lm	108Lm/W	G5-1163.2X15
LT5-18Y	4尺18W	0.17A	黃光3000K	1900 Lm	105Lm/W	G5-1163.2X15

■ 特性：

- 可以耐重複開關達30000次以上。
- 低損耗，可延長一般電子式安定器壽命。
- 光源不閃頻，有效保護視力。
- 光源壽命比螢光燈管長，維護成本低。
- 燈具材質：玻璃。
- 電源：適用於多數品牌電子安定器。
- 調光安定器不是用此類燈管。
- 台灣製造專利。

■ Characteristic：

- It can withstand repeated switching up to 30,000 times.
- Low loss, can extend the life of general electronic ballast.
- The light source does not flicker, which effectively protects eyesight.
- The life of the light source is longer than that of the fluorescent tube, and the maintenance cost is low.
- Lamp material: Glass.
- Power supply: suitable for most brand electronic ballasts.
- Dimming ballast is not used for this kind of lamp.
- Taiwan manufacturing patent.

智能雙色平板燈 intelligent two-color panel light



智能側光型60*60平板燈 35W

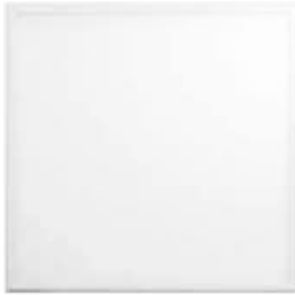

產品型號 Product number	額定電壓 Rated voltage	色溫範圍 Color temperature range	調光範圍 Dimming range	光通量 Luminous flux
AIML-DF3522-57	100V-240V	白光5700K	5%~100%	3850Lm
AIML-DF3522-40	100V-240V	暖白4000K	5%~100%	3700Lm

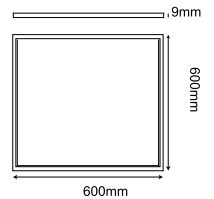

- 特性：
- 無需添加訊號線，安裝簡便
 - 智能線性無段式調光調色
 - 支援智慧分組管理設定
 - 支援多類型智能產品聯動
 - 支援時序控制設定
 - 同時支援RF無線遙控、遠端APP與AI智能語音控制

- characteristic：
- Easy to install without adding signal lines
 - Intelligent linear stepless dimming
 - Support smart group management settings
 - Support multi-type smart product linkage
 - Support timing control settings
 - Support RF wireless remote control, APP and AI intelligent voice control

智能超薄型直下式平板燈 35W



產品型號 Product number	額定電壓 Rated voltage	色溫範圍 Color temperature range	調光範圍 Dimming range	光通量 Luminous flux
AICM-DF3522-57	100V-240V	白光5700K	5%~100%	4400Lm
AICM-DF3522-40	100V-240V	暖白4000K	5%~100%	4200Lm
AICM-DF3522-30	100V-240V	黃光3000K	5%~100%	4000Lm
AICM-DF3522-WY	100V-240V	2700K-6500K	5%~100%	4200Lm

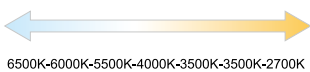
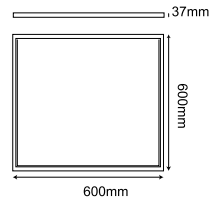

- 特性：
- 無需添加訊號線，安裝簡便
 - 智能線性無段式調光
 - 支援智慧分組管理設定
 - 支援多類型智能產品聯動
 - 支援時序控制設定
 - 同時支援RF無線遙控、遠端APP與AI智能語音控制

- characteristic：
- Easy to install without adding signal lines
 - Intelligent linear stepless dimming
 - Support smart group management settings
 - Support multi-type smart product linkage
 - Support timing control settings
 - Support RF wireless remote control, APP and AI intelligent voice control

平板燈選購配件



吊掛式配件：ML-DFHRC4
鋼索總長：150CM
適用規格：全尺寸規格

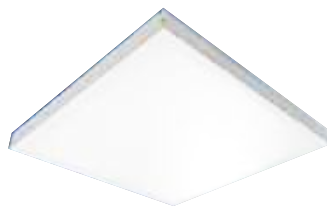

吸頂式配件：ML-DF22-CG
608mmX608mmX73mm
適用規格：600X600mm 平板



吸頂吊掛電源盒 ML-PBHRC4
適用規格：全尺寸規格

智能雙色平板燈 Intelligent two-color panel light



智能超薄型直下式平板燈30*120平板燈 35W

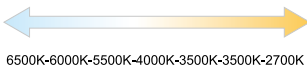

產品型號 Product number	額定電壓 Rated voltage	色溫範圍 Color temperature range	調光範圍 Dimming range	光通量 Luminous flux
AICM-DF3514-57	100V-240V	白光5700K	5%~100%	4200Lm
AICM-DF3514-40	100V-240V	暖白4000K	5%~100%	4000Lm
AICM-DF3514-30	100V-240V	黃光3000K	5%~100%	3800Lm
AICM-DF3514-WY	100V-240V	2700~6500K	5%~100%	4200Lm

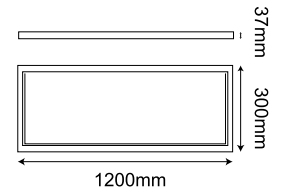

- 特性：
- 無需添加訊號線，安裝簡便
 - 智能線性無段式調光調色
 - 支援智慧分組管理設定
 - 支援多類型智能產品聯動
 - 支援時序控制設定
 - 同時支援RF無線遙控、遠端APP與AI智能語音控制

- characteristic：
- Easy to install without adding signal lines
 - Intelligent linear stepless dimming
 - Support smart group management settings
 - Support multi-type smart product linkage
 - Support timing control settings
 - Support RF wireless remote control, APP and AI intelligent voice control

智能超薄型直下式平板燈120*60平板燈 70W

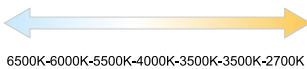

產品型號 Product number	額定電壓 Rated voltage	色溫範圍 Color temperature range	調光範圍 Dimming range	光通量 Luminous flux
AICM-DF7024-57	100V-240V	白光5700K	5%~100%	8400Lm
AICM-DF7024-40	100V-240V	暖白4000K	5%~100%	8300Lm
AICM-DF7024-30	100V-240V	黃光3000K	5%~100%	8200Lm
AICM-DF7024-WY	100V-240V	2700~6500K	5%~100%	8400Lm

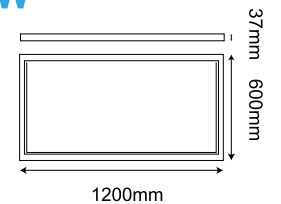

- 特性：
- 無需添加訊號線，安裝簡便
 - 智能線性無段式調光調色
 - 支援智慧分組管理設定
 - 支援多類型智能產品聯動
 - 支援時序控制設定
 - 同時支援RF無線遙控、遠端APP與AI智能語音控制

- characteristic：
- Easy to install without adding signal lines
 - Intelligent linear stepless dimming
 - Support smart group management settings
 - Support multi-type smart product linkage
 - Support timing control settings
 - Support RF wireless remote control, APP and AI intelligent voice control

平板燈選購配件



吊掛式配件：ML-DFHRC4
鋼索總長：150CM
適用規格：全尺寸規格



吸頂吊掛電源盒 ML-PBHRC4
適用規格：全尺寸規格

智能雙色吸頂燈 Smart two-color ceiling light



星光飛碟

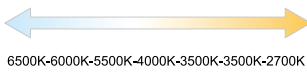

產品型號 Product number	額定電壓 Rated voltage	額定瓦數 Rated wattage	色溫範圍 Color temperature range	調光範圍 Dimming range	光通量 Luminous flux
ML-TA35-AI20	90V-240V	20W	2700~6500K	5%~100%	2000Lm
ML-TA40-AI40	90V-240V	40W	2700~6500K	5%~100%	4000Lm
ML-TA50-AI60	90V-240V	60W	2700~6500K	5%~100%	6000Lm

- 特性：
- 無需添加訊號線，安裝簡便
 - 智能線性無段式調光調色
 - 支援智慧分組管理設定
 - 支援多類型智能產品聯動
 - 支援時序控制設定
 - 同時支援RF無線遙控、遠端APP與AI智能語音控制

- characteristic :
- Easy to install without adding signal lines
 - Intelligent linear stepless dimming
 - Support smart group management settings
 - Support multi-type smart product linkage
 - Support timing control settings
 - Support RF wireless remote control, APP and AI intelligent voice control

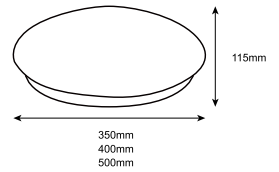

星光水鑽

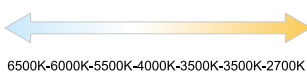

產品型號 Product number	額定電壓 Rated voltage	額定瓦數 Rated wattage	色溫範圍 Color temperature range	調光範圍 Dimming range	光通量 Luminous flux
ML-TA235-AI20	90V-240V	20W	2700~6500K	5%~100%	2000Lm
ML-TA240-AI40	90V-240V	40W	2700~6500K	5%~100%	4000Lm
ML-TA250-AI60	90V-240V	60W	2700~6500K	5%~100%	6000Lm

- 特性：
- 無需添加訊號線，安裝簡便
 - 智能線性無段式調光調色
 - 支援智慧分組管理設定
 - 支援多類型智能產品聯動
 - 支援時序控制設定
 - 同時支援RF無線遙控、遠端APP與AI智能語音控制

- characteristic :
- Easy to install without adding signal lines
 - Intelligent linear stepless dimming
 - Support smart group management settings
 - Support multi-type smart product linkage
 - Support timing control settings
 - Support RF wireless remote control, APP and AI intelligent voice control

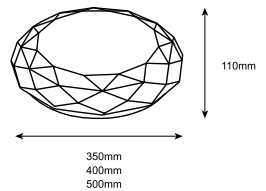

璀璨格菱

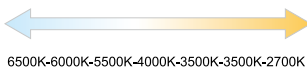

產品型號 Product number	額定電壓 Rated voltage	額定瓦數 Rated wattage	色溫範圍 Color temperature range	調光範圍 Dimming range	光通量 Luminous flux
ML-TA340-AI40	90V-240V	40W	2700~6500K	5%~100%	4000Lm
ML-TA350-AI60	90V-240V	60W	2700~6500K	5%~100%	6000Lm

- 特性：
- 無需添加訊號線，安裝簡便
 - 智能線性無段式調光調色
 - 支援智慧分組管理設定
 - 支援多類型智能產品聯動
 - 支援時序控制設定
 - 同時支援RF無線遙控、遠端APP與AI智能語音控制

- characteristic :
- Easy to install without adding signal lines
 - Intelligent linear stepless dimming
 - Support smart group management settings
 - Support multi-type smart product linkage
 - Support timing control settings
 - Support RF wireless remote control, APP and AI intelligent voice control

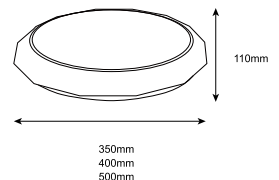

智能吸頂燈光源模組

Intelligent ceiling light source module

智能雙色吸頂燈光源模組 Intelligent two-color ceiling light source module

產品型號 Product number	額定電壓 Rated voltage	額定功率 rated power	色溫範圍 Color temperature range	調光範圍 Dimming range	光通量 Luminous flux	尺寸 Size
ML-AIPL-20	100V-240V	20W	2700~6500K	5%~100%	2000Lm	30X250mm
ML-AIPL-40	100V-240V	40W	2700~6500K	5%~100%	4000Lm	35X300mm
ML-AIPL-60	100V-240V	60W	2700~6500K	5%~100%	6000Lm	38X400mm

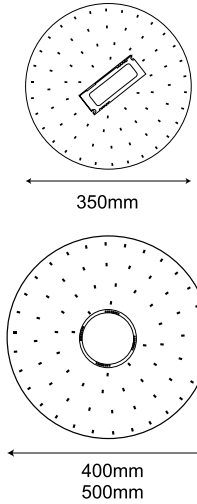
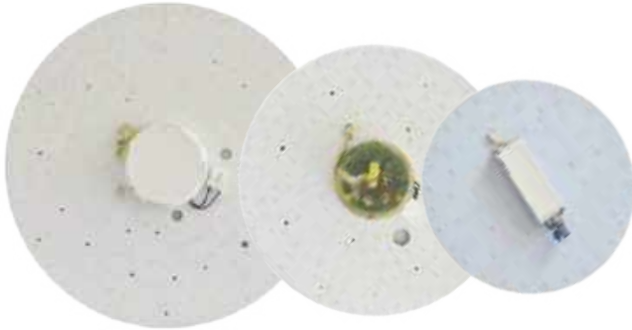

- 特性：
- 無需添加訊號線，安裝簡便
 - 智能線性無段式調光調色
 - 支援智慧分組管理設定
 - 支援多類型智能產品聯動
 - 支援時序控制設定
 - 同時支援RF無線遙控、遠端APP與AI智能語音控制

- characteristic :
- Easy to install without adding signal lines
 - Intelligent linear stepless dimming
 - Support smart group management settings
 - Support multi-type smart product linkage
 - Support timing control settings
 - Support RF wireless remote control, APP and AI intelligent voice control

智能雙色吸頂燈光源模組 Intelligent two-color ceiling light source module

產品型號 Product number	額定電壓 Rated voltage	額定功率 rated power	色溫範圍 Color temperature range	調光範圍 Dimming range	光通量 Luminous flux	尺寸 Size
ML-AIPL-100	100V-240V	100W	2700~6500K	5%~100%	10000Lm	40X600mm

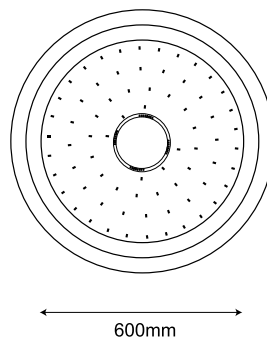

- 特性：
- 無需添加訊號線，安裝簡便
 - 智能線性無段式調光調色
 - 支援智慧分組管理設定
 - 支援多類型智能產品聯動
 - 支援時序控制設定
 - 同時支援RF無線遙控、遠端APP與AI智能語音控制

- characteristic :
- Easy to install without adding signal lines
 - Intelligent linear stepless dimming
 - Support smart group management settings
 - Support multi-type smart product linkage
 - Support timing control settings
 - Support RF wireless remote control, APP and AI intelligent voice control

※※產品不含燈座底板※※

LED停電照明轉換器



LED power failure lighting converter

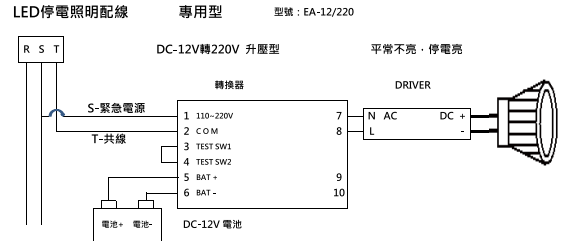

產品尺寸：215X45X28mm

LED停電轉換器-專用型

產品型號 Product number	規格 Specification	輸出功率 Output Power	功能 Function	輸出電壓 The output voltage	電池規格 Battery specifications	充電時間 Charging time
EA-12/220	專用型	≤25W	平常不亮、停電亮	DC 220V	DC-12V	48 HR

■ 特性：

- 輸入電壓100-220Vdc
- 專用型：平常不亮、停電亮
- 複合型：平常亮、停電亮
- 定電流充電設計，延長電池壽命
- 智慧型過充及過放線路，保護電池
- 電壓變化自動補償
- 材質：鋁本體外盒
- 點燈時間依據電池容量
- 符合消防法規

■ Characteristic：

- Input voltage 100-220Vdc
- Special type: usually not bright, power outage bright
- Composite type: normal light, power outage light
- Constant current charging design to extend battery life
- Intelligent overcharge and overdischarge circuit to protect the battery
- Automatic compensation for voltage changes
- Material: aluminum outer box
- Lighting time is about 90 minutes
- Comply with fire protection regulations

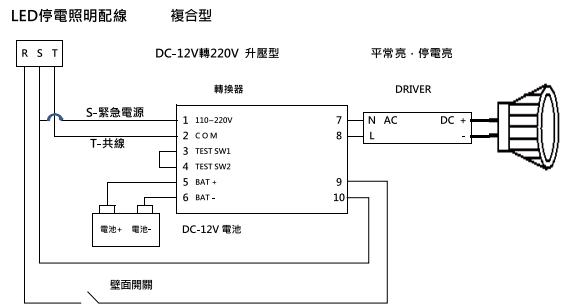

產品尺寸：215X45X28mm

LED停電轉換器-複合型

產品型號 Product number	規格 Specification	輸出功率 Output Power	功能 Function	輸出電壓 The output voltage	電池規格 Battery specifications	充電時間 Charging time
EC-12/220	複合型	≤25W	平常亮、停電亮	DC 220V	DC-12V	48 HR

■ 特性：

- 輸入電壓100-220Vdc
- 專用型：平常不亮、停電亮
- 複合型：平常亮、停電亮
- 定電流充電設計，延長電池壽命
- 智慧型過充及過放線路，保護電池
- 電壓變化自動補償
- 材質：鋁本體外盒
- 點燈時間依據電池容量
- 符合消防法規

■ Characteristic：

- Input voltage 100-220Vdc
- Special type: usually not bright, power outage bright
- Composite type: normal light, power outage light
- Constant current charging design to extend battery life
- Intelligent overcharge and overdischarge circuit to protect the battery
- Automatic compensation for voltage changes
- Material: aluminum outer box
- Lighting time is about 90 minutes
- Comply with fire protection regulations

電子安定器 Electronic ballast

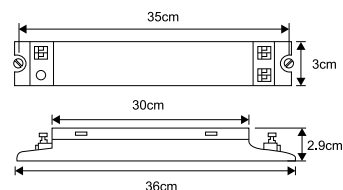

■ 特性：

- 功率因素達99%，省電30%。
- 燈管預熱啟動，延長燈管壽命。
- 高頻點燈，燈管不閃爍，保護視力。
- 智慧型開路，短路及燈管異常安全保護。
- 採主動功因設計，低諧波，可耐電壓變動。
- 請在周圍濕度80%以下使用。
- 安裝時請務必接地。
- 更換燈管時請將電源切斷。
- 應配合使用指定燈管。
- 本安裝器適用於室內
- 自行安裝時請依標籤電路圖所示安裝。

■ Characteristic：

- The power factor reaches 99% and the power saving is 30%.
- The hot start of the lamp tube extends the life of the lamp tube.
- High-frequency lighting, the tube does not flicker to protect eyesight.
- Intelligent open circuit, short circuit and abnormal lamp safety protection.
- Adopt active power factor design, low harmonics, and can withstand voltage changes.
- Please use it under 80% ambient humidity.
- Be sure to ground it when installing.
- Turn off the power when replacing the lamp.
- The designated lamps should be used together.
- This installer is suitable for indoor use
- When installing by yourself, please install it according to the label circuit diagram.

T-T5系列 T-T5 Series 尺寸：293X19X22mm

產品型號 Product number	燈管 Lamp tube	輸入電壓 Input voltage	輸入電流 Input Current	適用燈管 Input Current	功率因素 Power Factor	工作頻率 Working frequency	適用溫度範圍 Applicable temperature range
EB-UF514T1	1	100-240V	0.04-0.1A	8-14W	0.99以上	>40KHz	0~50°C
EB-UF528T1	1	100-240V	0.09-0.28A	21-28W	0.99以上	>40KHz	0~50°C

H-FL系列 H-FL Series 尺寸：325X30X30mm

產品型號 Product number	燈管 Lamp tube	輸入電壓 Input voltage	輸入電流 Input Current	適用燈管 Input Current	功率因素 Power Factor	工作頻率 Working frequency	適用溫度範圍 Applicable temperature range
EB-UFL40H1	1	100-240V	0.08-0.4A	20/30/40W	0.99以上	>40KHz	0~50°C
EB-UFL40H2	2	100-240V	0.17-0.8A	20/30/40W	0.99以上	>40KHz	0~50°C
EB-UFL20H3	3	100-240V	0.25-0.6A	20W	0.99以上	>40KHz	0~50°C
EB-UFL20H4	4	100-240V	0.34-0.8A	20W	0.99以上	>40KHz	0~50°C

H-T5系列 H-T5 Series 尺寸：325X30X30mm (1-2頂) / 225X30X30mm (3-4頂)

產品型號 Product number	燈管 Lamp tube	輸入電壓 Input voltage	輸入電流 Input Current	適用燈管 Input Current	功率因素 Power Factor	工作頻率 Working frequency	適用溫度範圍 Applicable temperature range
EB-UT528H1	1	100-240V	0.05-0.35A	14/21/28/35W	0.99以上	>40KHz	0~50°C
EB-UT528H2	2	100-240V	0.11-0.7A	14/21/28/35W	0.99以上	>40KHz	0~50°C
EB-UT528H2	2	100-240V	0.28-0.57A	14/21/28W	0.99以上	>40KHz	0~50°C
EB-UT514H4	3/4	100-240V	0.29-0.58A	14W	0.99以上	>40KHz	0~50°C

L-FL系列 L-FL Series 尺寸：360X30X30mm

產品型號 Product number	燈管 Lamp tube	輸入電壓 Input voltage	輸入電流 Input Current	適用燈管 Input Current	功率因素 Power Factor	工作頻率 Working frequency	適用溫度範圍 Applicable temperature range
EB-UFL40L3	3	200-240V	0.25-0.6A	20/30/40W	0.99以上	>40KHz	0~50°C
EB-UFL32L3	3	100-240V	0.4-0.96A	32W	0.99以上	>40KHz	0~50°C

L-T5系列 L-T5 Series 尺寸：360X30X30mm

產品型號 Product number	燈管 Lamp tube	輸入電壓 Input voltage	輸入電流 Input Current	適用燈管 Input Current	功率因素 Power Factor	工作頻率 Working frequency	適用溫度範圍 Applicable temperature range
EB-UT528L3	3	100-240V	0.26-0.84A	21/28W	0.99以上	>40KHz	0~50°C

**MD27-GA SD-5044-1**

□ / E27 球型 / CRI90 / 鋁製品、PMMA / 100-240V



	光源尺寸 (mm)	光學角度	色溫 (K)	晶片廠牌
5W	113×H59 mm	240°	3000/4000	
9.5W			2200/2700 3000/3500 4000/5000/6500	
13W	132×H70 mm			

**MD27-PA SD-5044-2**

□ / E27 PAR20 / CRI90 / 鋁製品、PMMA / 100-240V



	光源尺寸 (mm)	光學角度	色溫 (K)	晶片廠牌
10W	61×H76 mm	25° 40° 60°	2200/2700 3000/3500 4000/5000/6500	

**MD27-PB SD-5044-3**

□ / E27 PAR30 / CRI90 / 鋁製品、PMMA / 100-240V



	光源尺寸 (mm)	光學角度	色溫 (K)	晶片廠牌
12W	96×H107 mm	25° 40° 60°	2200/2700 3000/3500 4000/5000/6500	
15W			2700 ~ 6500 調光調色	
15W (CRI80)			40° 60°	

**MD27-PC SD-5044-4**

□ / E27 PAR38 / CRI90 / 鋁製品、PMMA / 100-240V



	光源尺寸 (mm)	光學角度	色溫 (K)	晶片廠牌
12W	120×H131 mm	25° 40° 60°	2200/2700 3000/3500 4000/5000/6500	
15W			2700 ~ 6500 調光調色	
15W (CRI80)			40° 60°	

§ SMD 可訂製 紅光 / 藍光 / 綠光，需另加價。

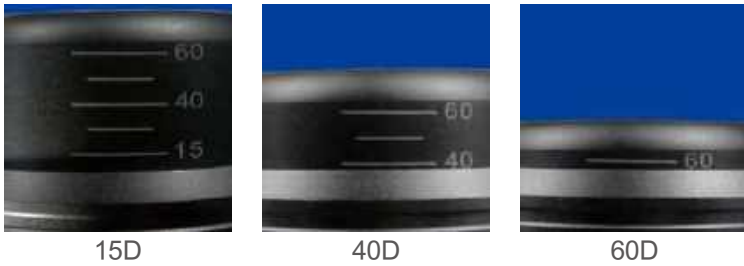

MD27-PD 全光譜 PAR20 SD-5045-1

■ / E27 / CRI90 / 鋁製品、PMMA / 100-240V



	光源尺寸 (mm)	光學角度	色溫 (K)	晶片廠牌
10W	60×H105~125 mm	15° ~ 60°	2700/3000/3500 4000/5000	
10W			3000/4000 (全光譜)	

※ 演色性質 < 全光譜 >

T _{CP} (K)	R _a	R ₉	R ₁₀	R ₁₁	R ₁₂	R ₁₃	R ₁₄	R ₁₅
4000	98	98	98	92	89	98	99	99
3000	97	92	98	91	93	97	97	96



MDMR-GA SD-5046-1

■ / MR16-GU5.3 / CRI90 / 鋁製品、PMMA / DC12V



	光源尺寸 (mm)	光學角度	色溫 (K)	晶片廠牌
4W	50×H47 mm	30°	2200/2700 3000/3500 4000/5000/6500	NICHIA



MDMR-GB SD-5046-2

■ / MR16-GU5.3 / CRI90 / 鋁製品、PMMA / DC12V



	光源尺寸 (mm)	光學角度	色溫 (K)	晶片廠牌
7W	50×H47 mm	30°	2200/2700 3000/3500 4000/5000/6500	NICHIA



MDMR-SA SD-5046-3

■□ / MR16-SMD / CRI90 / 鋁製品、PMMA / 100-240V



	光源尺寸 (mm)	光學角度	色溫 (K)	晶片廠牌
5W	49×H26 mm	40° 60°	2200/2700 3000/3500 4000/5000/6500	NICHIA

§ SMD 可訂製 紅光 / 藍光 / 綠光，需另加價。

超薄款



MDMR-CA SD-5047-1

MR16-COB / CRI90 / 鋁製品、PMMA / 100-240V



	光源尺寸 (mm)	光學角度	色溫 (K)	晶片廠牌
7W	50×H26 mm	15°	2700/3000/3500 4000/5000	NICHIA
7W			3000/4000 (全光譜)	
7W		38°	2700 ~ 6500 調光調色	bridgelux.



MDMR-SB SD-5047-2

MR16-SMD / CRI90 / 鋁製品、PMMA / 100-240V



	光源尺寸 (mm)	光學角度	色溫 (K)	晶片廠牌
7W	50×H55 mm	25° 40° 60° 140°	3000+RGB	NICHIA
10W			2200/2700 3000/3500 4000/5000/6500	
10W (CRI80)		40° 60° 140°	2700 ~ 6500 調光調色	



MDMR-SC SD-5047-3

MR16-SMD / CRI80 / 鋁製品、PMMA / 100-240V



	光源尺寸 (mm)	光學角度	色溫 (K)	晶片廠牌
7W	50×H55 mm	10°	2700/3000 4000/5000	NICHIA



MDMR-CB SD-5047-4

MR16-COB / CRI90 / 鋁製品、鋁製光杯 / 100-240V



	光源尺寸 (mm)	光學角度	色溫 (K)	晶片廠牌
7W	50×H55 mm	15°	2700/3000/3500 4000/5000	NICHIA
10W			3000/4000 (全光譜)	
15W		30°	2700 ~ 6500 調光調色	bridgelux.
10W		60°		
10W				

§ SMD 可訂製 紅光 / 藍光 / 綠光，需另加價。

MR16 MODULE (MDMR)

**MDAR-SA SD-5048-1**

■ ■ / AR111 / CRI90 / 鋁製品、PMMA / 100-240V



	光源尺寸 (mm)	光學角度	色溫 (K)	晶片廠牌
7W	111×H25 mm	25° 40° 60°	3000+RGB	
10W			2200/2700 3000/3500 4000/5000/6500	
10W (CRI80)			2700 ~ 6500 調光調色	

**MDAR-SB SD-5048-2**

■ ■ □ / AR111 / CRI90 / 鋁製品、PMMA / 100-240V



	光源尺寸 (mm)	光學角度	色溫 (K)	晶片廠牌
12W	111×H35 mm	25° 40° 60°	2200/2700 3000/3500 4000/5000/6500	
20W (CRI80)			2700/3000 4000/5000	

**MDAR-SC SD-5048-3**

■ ■ □ / AR111 / CRI90 / 鋁製品、PMMA / 100-240V



	光源尺寸 (mm)	光學角度	色溫 (K)	晶片廠牌
15W	111×H35 mm	25° 40° 60°	2200/2700 3000/3500 4000/5000/6500	
35W 45W (CRI80)	111×H61 mm		2700/3000 4000/5000	
15W 20W (CRI80)	111×H35 mm		2700 ~ 6500 調光調色	
30W (CRI80)	111×H61 mm			

§ SMD15W 以下可訂製 紅光 / 藍光 / 綠光，需另加價。
§ 白色 AR111 為訂製品，需另加價。



MDAR-PA SD-5049-1

■□ / AR111 / CRI90 / 鋁製品、PMMA / 100-240V



	光源尺寸 (mm)	光學角度	色溫 (K)	晶片廠牌
12W	111×H35 mm	140°	2200/2700 3000/3500 4000/5000/6500	
15W				
24W				
32W	111×H61 mm			
15W	111×H35 mm		2700 ~ 6500 調光調色	
30W (CRI80)	111×H61 mm			



2200K 2700K 3000K 3500K 4000K 5000K 6500K

§ SMD 可訂製 紅光 / 藍光 / 綠光，需另加價。
§ 白色 AR111 為訂製品，需另加價。



MDAR-SD SD-5050-1

■□ / AR111 / CRI80 / 鋁製品、PMMA / 100-240V



	光源尺寸 (mm)	光學角度	色溫 (K)	晶片廠牌
7W	111×H50 mm	6°	2700/3000/4000/5000	NICHIA



MDAR-CA SD-5050-2

■□ / AR111 / CRI90 / 鋁製品、PMMA / 100-240V



	光源尺寸 (mm)	光學角度	色溫 (K)	晶片廠牌
12W	111×H35 mm	24° 38°	2700/3000/3500 4000/5000	NICHIA
15W				
22W				
30W	111×H61 mm			
15W	111×H35 mm		3000/4000 (全光譜)	
15W		2700 ~ 6500 調光調色		

§ 白色 AR111 為訂製品，需另加價。



MDAR-CB SD-5051-1

■ / AR111 / CRI90 / 鋁製品、PC / 100-240V



	光源尺寸 (mm)	光學角度	色溫 (K)	晶片廠牌
15W	111×H60 mm	15° 30° 45°	2700/3000/3500 4000/5000	
22W				
30W	111×H90 mm			
45W				
15W	111×H60 mm		3000/4000 (全光譜)	
15W		2700 ~ 6500 調光調色		

48V 磁吸軌道系統

嵌入式、吸頂式、吊掛式

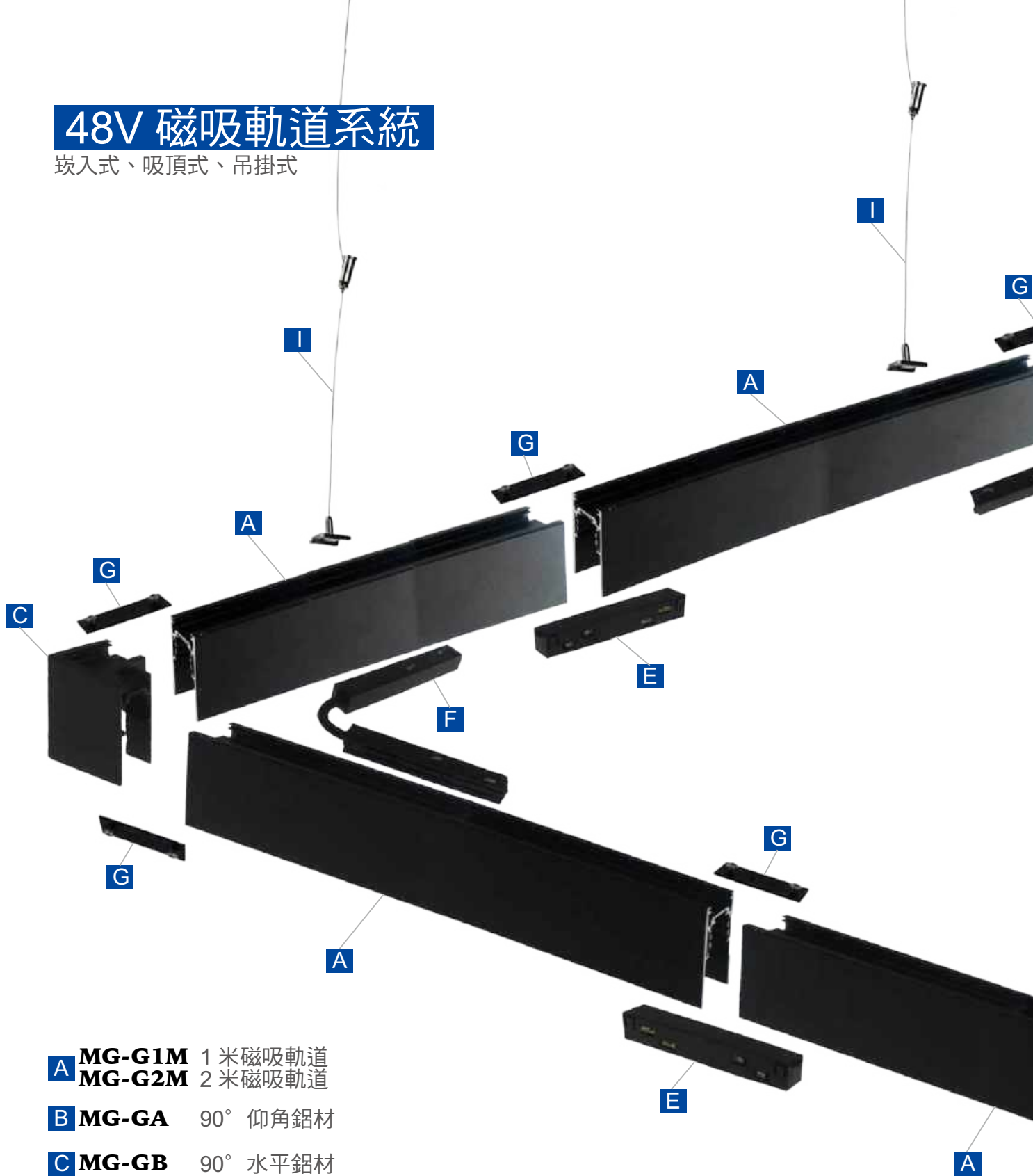

A **MG-G1M** 1米磁吸軌道
MG-G2M 2米磁吸軌道

B **MG-GA** 90° 仰角鋁材

C **MG-GB** 90° 水平鋁材

D **MG-GE** 取電模塊

E **MG-GF** 導電直接模塊

F **MG-GG** 導電軟接模塊

G **MG-GH** 連接片

H **MG-GI** 軌道側蓋

J **MG-GC** 十字鋁材

I **MG-GJ** 吊索 <150CM>

K **MG-GD** T字鋁材

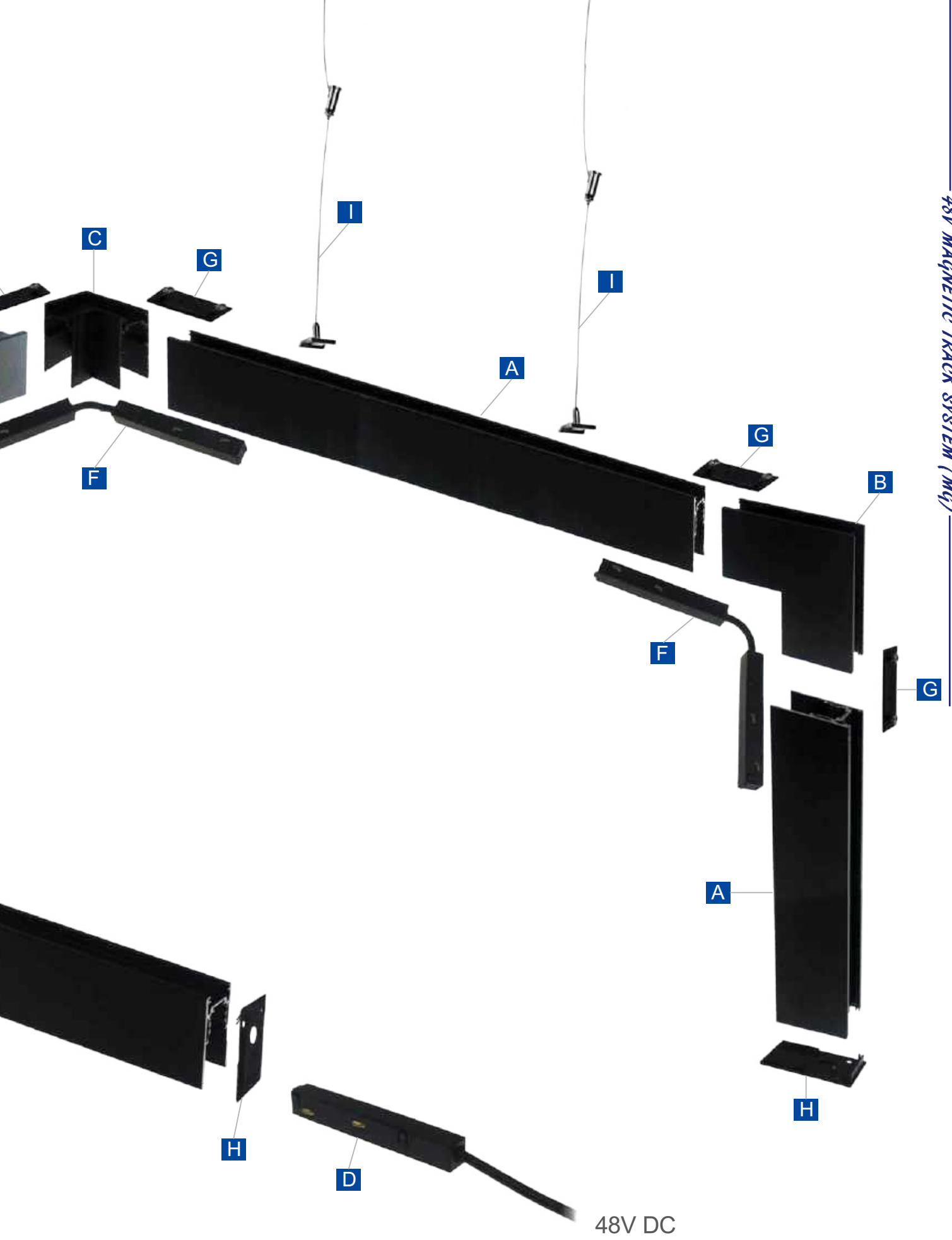

MG-G1M/MG-G2M 磁吸軌道

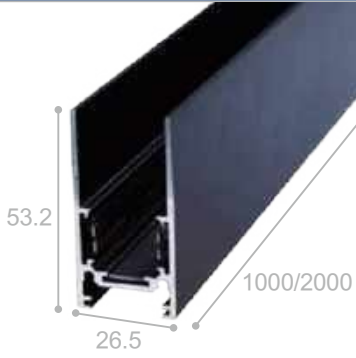

SD-5054-1

MG-GA 90° 仰角鋁材

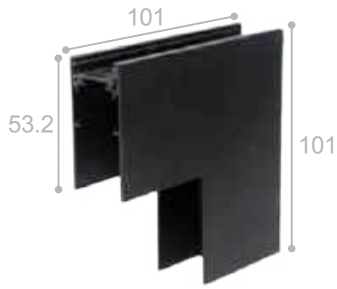

SD-5054-2

MG-GB 90° 水平鋁材



SD-5054-3

MG-GE 取電模塊



SD-5054-4

MG-GF 導電直接模塊



SD-5054-5

MG-GG 導電軟接模塊

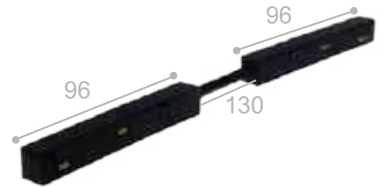

SD-5054-6

MG-GH 連接片



SD-5054-7

MG-GI 軌道側蓋



SD-5054-8

MG-GJ 吊索 <150CM>



SD-5054-9

MG-GC 十字鋁材

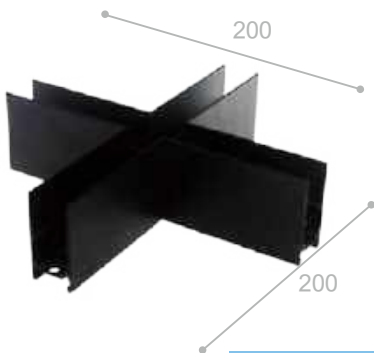

SD-5054-10

MG-GD T字鋁材

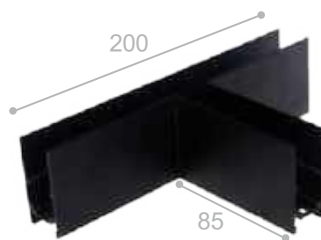

SD-5054-11

ML-EA 鋁材吊燈



SD-5054-12

※ 單位：±1mm

**ML-AA SD-5055-1**

■□ / COB 模組 / CRI90
鋁製品 / 48V



	尺寸 (mm)	光學角度	色溫 (K)
7W	55×77×H160	20°	2700/3000/3500 4000/5000
12W		40°	
12W			2700 ~ 6500 調光調色

ML-AB SD-5055-2

■□ / COB 模組 / CRI90
鋁製品 / 48V



	尺寸 (mm)	光學角度	色溫 (K)
7W	60×100×H180	15°	2700/3000/3500 4000/5000
12W		30°	
12W		60°	2700 ~ 6500 調光調色

**ML-AC SD-5055-3**

■□ / COB 模組 / CRI90
鋁製品 / 48V



	尺寸 (mm)	光學角度	色溫 (K)
7W	42×107×H160	20°	2700/3000/3500 4000/5000
12W		40°	
12W			2700 ~ 6500 調光調色

ML-AD SD-5055-4

■□ / COB 模組 / CRI90
鋁製品 / 48V



	尺寸 (mm)	光學角度	色溫 (K)
7W	50×138×H200	20°	2700/3000/3500 4000/5000
12W			
18W		40°	
12W			2700 ~ 6500 調光調色

§ 此頁軌道燈可訂製全光譜 12W —— 色溫 3000K / 4000K

§ 磁吸軌道系列，白色為訂製品，需另加價。

§ 2700~6500K 調光調色晶片為 [bridgelux](#)。



ML-BA SD-5056-1

■□ / SMD 模組 / CRI90 / 鋁製品 / 48V



NICHIA

	尺寸 (mm)	光學角度	色溫 (K)
6W	24×111×H45	40°	2200/2700/3000/3500 4000/5000/6500
12W	24×220×H45		



ML-BB SD-5056-2

■□ / SMD 模組 / CRI90 / 鋁製品 / 48V



NICHIA

	尺寸 (mm)	光學角度	色溫 (K)
12W	24×220×H110	40°	2200/2700/3000/3500 4000/5000/6500

- § 磁吸軌道系列，白色為訂製品，需另加價。
- § 可訂製 紅光 / 藍光 / 綠光，需另加價。

**ML-CA SD-5057-1**

□ / SMD 模組 / CRI90 / 鋁製品 / 48V



	尺寸 (mm)	光學角度	色溫 (K)
3W*2	G70×2 170×H115	240°	2200/2700/3000/3500 4000/5000/6500

**ML-DA SD-5057-2**

■ □ / SMD 模組 / CRI90 / 鋁製品 / 48V



	尺寸 (mm)	光學角度	色溫 (K)
6W	22×300×H26	140°	2700/3000/3500 4000/5000/6500
6W			2700 ~ 6500 調光調色

**ML-DB SD-5057-3**

■ □ / SMD 模組 / CRI90 / 鋁製品 / 48V



	尺寸 (mm)	光學角度	色溫 (K)
6W	22×602×H26	140°	2700/3000/3500 4000/5000/6500
12W			
18W			
6W			2700 ~ 6500 調光調色
12W			

§ 磁吸軌道系列，白色為訂製品，需另加價。

高壓型二線式軌道燈



TLMD-DA SD-5058-1

■□ / COB & SMD 模組 / CRI90 / 鋁製品、鐵 / 100-240V



	尺寸 (mm)	光學角度	色溫 (K)	晶片廠牌
7W COB	55×77×H200/230	20° 40°	2700/3000/3500 4000/5000	
10W SMD		25° 40° 60°	2200/2700/3000/3500 4000/5000/6500	



TLMD-DB SD-5058-2

■□ / COB 模組 / CRI90 / 鋁製品、鐵 / 100-240V



	尺寸 (mm)	光學角度	色溫 (K)	晶片廠牌
7W	42×107×H200/230	20° 40°	2700/3000/3500 4000/5000	

§ SMD 可訂製 紅光 / 藍光 / 綠光，需另加價。



TLMD-DC SD-5059-1

■□ / COB & SMD 模組 / CRI90 / 鋁製品、鐵 / 100-240V



	尺寸 (mm)	光學角度	色溫 (K)	晶片廠牌
7W COB	60×100×H180/210	15° 30° 60°	2700/3000/3500 4000/5000	
5W SMD		40° 60°	2200/2700/3000/3500 4000/5000/6500	
10W SMD		25° 40° 60°		



TLMD-DD SD-5059-2

■□ / SMD 模組 / CRI90 / 鋁製品、鐵 / 100-240V



	尺寸 (mm)	光學角度	色溫 (K)	晶片廠牌
12W	74×120×H210/240	25° 40° 60°	2200/2700/3000/3500 4000/5000/6500	
15W				

§ SMD 可訂製 紅光 / 藍光 / 綠光，需另加價。



55° 75×140°

TLMD-AA SD-5060-1

■□ / 36 燈 SMD 模組 / CRI90 / 鋁製品 / 100-240V



	尺寸 (mm)	光學角度	色溫 (K)	晶片廠牌
30W	220×43×H150	55°	2200/2700 3000/3500	NICHIA
40W		75×140°	4000/5000/6500	

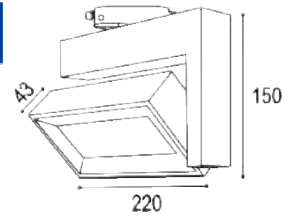

TLMD-AB SD-5060-2

■□ / 6 燈 SMD 模組 / CRI90 / 鋁製品 / 100-240V



	尺寸 (mm)	光學角度	色溫 (K)	晶片廠牌
8W	115×25×H140	25°	2200/2700 3000/3500 4000/5000/6500	NICHIA

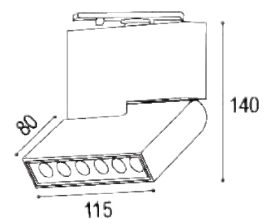

§ SMD 可訂製 紅光 / 藍光 / 綠光，需另加價。

8 SMD 可訂製 紅光 / 藍光 / 綠光，需另加價。



TRACK LIGHTING (TLMD)

TLMD-AC SD-5061-1

10 燈 SMD 模組 / CRI90 / 鋁製品 / 100-240V



	尺寸 (mm)	光學角度	色溫 (K)	晶片廠牌
14W	270×35×H95	40° 60°	2200/2700 3000/3500 4000/5000/6500	NICHIA

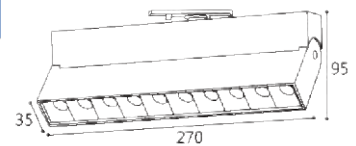

TLMD-BA SD-5062-1



(1) 萬向可調



(2) 迷你雙搖桿

■□ / SMD 模組 / CRI90 / 鋁製品、PC 罩 / 100-240V

軌道方式 : (1) 萬向可調 (2) 迷你雙搖桿



	光源尺寸 (mm)	光學角度	色溫 (K)	晶片廠牌
18W/36W	W50×H50×1200	140°	2700/3000/3500 4000/5000/6500	
18W/36W			2700 ~ 6500 調光調色	



(1) 萬向可調 (2) 迷你雙搖桿

TLMD-BB SD-5063-1

■□ / SMD 模組 / CRI90 / 鋁製品、PC 罩 / 100-240V

軌道方式 : (1) 萬向可調 (2) 迷你雙搖桿



	光源尺寸 (mm)	光學角度	色溫 (K)	晶片廠牌
36W	W38×H60×1200	270°	2700/3000/3500 4000/5000/6500	
36W			2700 ~ 6500 調光調色	



(1) 萬向可調 (2) 迷你雙搖桿

TLMD-BC SD-5063-2

■□ / SMD 模組 / CRI90 / 鋁製品、PC 罩 / 100-240V

軌道方式 : (1) 萬向可調 (2) 迷你雙搖桿



	光源尺寸 (mm)	光學角度	色溫 (K)	晶片廠牌
18W	W28×H50×1200	140°	2700/3000/3500 4000/5000/6500	
18W			2700 ~ 6500 調光調色	

TLMD-CA

SD-5064-1





TLMD-CB

SD-5064-2



■ / COB 模組 / CRI90 / 鋁製品 / 100-240V



	光源尺寸 (mm)	光學角度	色溫 (K)	晶片廠牌
10W	單燈 92×185×H43mm 雙燈 92×300×H43mm	20° 40°	2700/3000/3500 4000/5000	
15W			3000/4000 (全光譜)	
10W			2700 ~ 6500 調光調色	
10W				

TLMR-BA
SD-5065-1



TLAR-BA
SD-5065-3



TLMR-BB
SD-5065-2



TLAR-BB
SD-5065-4



■ / □ (訂製品)

MR16 燈具	尺寸 (mm)	材質
單燈	114×114×H130	鋼板烤漆 / 塑膠
雙燈	114×218×H130	
適用光源		



■ / □ (訂製品)

AR111 燈具	尺寸 (mm)	材質
單燈	160×160×H160	鋼板烤漆 / 塑膠
雙燈	160×310×H160	
適用光源		



**TLMD-CC SD-5066-1**
 / COB 模組 / CRI90 / 鋁製品 / 100-240V

	尺寸 (mm)	光學角度	色溫 (K)	晶片廠牌
20W	95×135×H200	15°	2700/3000/3500 4000/5000	NICHIA
30W			3000/3500 4000/5000	
45W		45°	3000/4000	bridgelux.
15W			2700 ~ 6500 調光調色	

**TLMD-CD SD-5066-2**
 / COB 模組 / CRI90 / 鋁製品 / 100-240V

	尺寸 (mm)	光學角度	色溫 (K)	晶片廠牌
20W	95×135×H205	15°	2700/3000/3500 4000/5000	NICHIA
30W			3000/3500 4000/5000	
45W		45°	3000/4000	bridgelux.
15W			2700 ~ 6500 調光調色	

**TLMD-CE SD-5066-3**
 / COB 模組 / CRI90 / 鋁製品 / 100-240V

	尺寸 (mm)	光學角度	色溫 (K)	晶片廠牌
20W	95×135×H185	15°	2700/3000/3500 4000/5000	NICHIA
30W			3000/3500 4000/5000	
45W		45°	3000/4000	bridgelux.
15W			2700 ~ 6500 調光調色	

**TLMD-CF SD-5066-4**
 / COB 模組 / CRI90 / 鋁製品 / 100-240V

	尺寸 (mm)	光學角度	色溫 (K)	晶片廠牌
15W	76×95×H130	15°	2700/3000/3500 4000/5000	NICHIA
20W		30°		
15W		45°	2700 ~ 6500 調光調色	bridgelux.

§ 此頁軌道燈可訂製全光譜 15W —— 色溫 3000K / 4000K

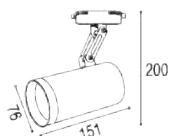

TLMD-CG SD-5067-1

☐■ / COB 模組 / CRI90 / 鋁製品 / 100-240V



	尺寸 (mm)	光學角度	色溫 (K)	晶片廠牌
15W	76×170×H200	16°	2700/3000/3500 4000/5000	NICHIA
20W		28°		
15W		42°	2700 ~ 6500 調光調色	bridgelux.

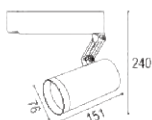

TLMD-CH SD-5067-2

☐■ / COB 模組 / CRI90 / 鋁製品 / 100-240V



	尺寸 (mm)	光學角度	色溫 (K)	晶片廠牌
20W	76×170×H240	16°	2700/3000/3500 4000/5000	NICHIA
30W		28°		
15W		42°	2700 ~ 6500 調光調色	bridgelux.

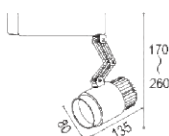

TLMD-CI SD-5067-3

☐■ / COB 模組 / CRI90 / 鋁製品 / 100-240V



	尺寸 (mm)	光學角度	色溫 (K)	晶片廠牌
20W	80×135×H260	16°	2700/3000/3500 4000/5000	NICHIA
30W		28°		
15W		42°	2700 ~ 6500 調光調色	bridgelux.

§ 此頁軌道燈可訂製全光譜 15W —— 色溫 3000K / 4000K

MINI 軌道燈

**TLMD-CJ SD-5068-1**

■□ / COB 模組 / CRI90 / 鋁製品、鐵 / 100-240V



	尺寸 (mm)	光學角度	色溫 (K)	晶片廠牌
7W	42×107×H150	20°	2700/3000/3500 4000/5000	
10W				
15W				
10W			2700 ~ 6500 調光調色	

**TLMD-CK SD-5068-2**

■□ / COB 模組 / CRI90 / 鋁製品、鐵 / 100-240V



	尺寸 (mm)	光學角度	色溫 (K)	晶片廠牌
10W	50×138×H190	20°	2700/3000/3500 4000/5000	
15W				
20W				
15W			2700 ~ 6500 調光調色	

§ 此頁軌道燈可訂製全光譜 10W —— 色溫 3000K / 4000K



TLMR-AE
SD-5069-1



COB TRACK LIGHTING (TLMP)



鋁製光罩片 絲綢網 Ai 調色調光 IEC 無線光色管 無線遙控 Wi-Fi APP 遙控

顏色

材質

MR16 燈具

■ 金

鋁製品 / 塑膠

適用光源



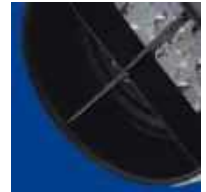

※ 配件：十字格

**TLMD-SA SD-5070-1**

■□ / SMD 模組 / CRI90 / 鋁製品、鐵 / 100-240V



AI 顏色調光

IEC 顏色準確

無線連接

APP / APP 遙控

	尺寸 (mm)	光學角度	色溫 (K)	晶片廠牌
12W/15W	120×60×H200	25° 40° 60°	2200/2700/3000/3500 4000/5000/6500	
20W (CRI80)			2700/3000 4000/5000	
35W/45W (CRI80)	120×85×H200	40° 60°	2700 ~ 6500 調光調色	
15W/20W (CRI80)	120×60×H200			
30W (CRI80)	120×85×H200			

**TLMD-SB SD-5070-2**

■□ / SMD 模組 / CRI90 / 鋁製品、鐵 / 100-240V



AI 顏色調光

IEC 顏色準確

無線連接

APP / APP 遙控

	尺寸 (mm)	光學角度	色溫 (K)	晶片廠牌
12W/15W	120×85×H200	25° 40° 60°	2200/2700/3000/3500 4000/5000/6500	
20W (CRI80)			2700/3000 4000/5000	
35W/45W (CRI80)	120×110×H200	40° 60°	2700 ~ 6500 調光調色	
15W/20W (CRI80)	120×85×H200			
30W (CRI80)	120×110×H200			

§ SMD15W 以下可訂製 紅光 / 藍光 / 綠光，需另加價。

※ 配件：四葉片

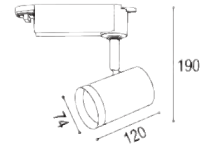
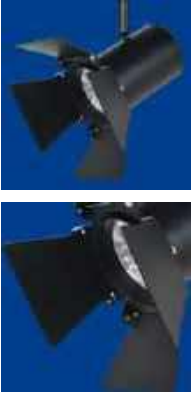

TLMD-SC SD-5071-1

■□ / SMD 模組 / CRI90 / 鋁製品、鐵 / 100-240V



	尺寸 (mm)	光學角度	色溫 (K)	晶片廠牌
12W/15W	74×120×H190	25° 40° 60°	2200/2700/3000/3500 4000/5000/6500	
20W/30W (CRI80)			2700/3000/4000/5000	
15W/30W (CRI80)		40° 60°	2700 ~ 6500 調光調色	



TLMD-CL SD-5071-2

■□ / COB 模組 / CRI90 / 鋁製品、鐵 / 100-240V



	尺寸 (mm)	光學角度	色溫 (K)	晶片廠牌
15W	76×95×H215	16° 28° 42°	2700/3000/3500 4000/5000	
20W			3000/4000 (全光譜)	
15W			2700 ~ 6500 調光調色	
15W				

§ SMD15W 以下可訂製 紅光 / 藍光 / 綠光，需另加價。



TLMD-SD SD-5072-1

■□ / SMD 模組 / CRI90 / 鋁製品 / 100-240V



	尺寸 (mm)	光學角度	色溫 (K)	晶片廠牌
7W	90×40×H160	25° 40° 60°	3000+RGB	NICHIA
10W			2200/2700/3000/3500 4000/5000/6500	
10W (CRI80)		40° 60°	2700 ~ 6500 調光調色	



TLMD-SE SD-5072-2

	尺寸 (mm)	光學角度	色溫 (K)
12W	90×40×H160	25° 40° 60°	2200/2700 3000/3500 4000/5000/6500
20W (CRI80)	90×65×H160		2700/3000 4000/5000



TLMD-SF SD-5072-3

	尺寸 (mm)	光學角度	色溫 (K)
15W	90×65×H160	25° 40° 60°	2200/2700 3000/3500 4000/5000/6500
15W (CRI80)			40° 60°



TLMD-SG SD-5072-4

	尺寸 (mm)	光學角度	色溫 (K)
24W	100×80×H170	140°	2200/2700 3000/3500 4000/5000/6500
24W 30W (CRI80)		25° 40° 60°	2700/3000 4000/5000
30W (CRI80)		40° 60°	2700 ~ 6500 調光調色



TLMD-SH SD-5072-5

	尺寸 (mm)	光學角度	色溫 (K)
7W (CRI80)	100×80×H170	6°	2700/3000 4000/5000



■□ / SMD 模組 / CRI90 / 鋁製品、鐵 / 100-240V



§ SMD15W 以下可訂製紅光 / 藍光 / 綠光，需另加價。



	尺寸 (mm)	光學角度	色溫 (K)		尺寸 (mm)	光學角度	色溫 (K)
7W	90×40×H160	25° 40° 60°	3000+RGB	12W	90×40×H160	25° 40° 60°	2200/2700 3000/3500 4000/5000/6500
10W			2200/2700 3000/3500 4000/5000/6500	15W			4000/5000/6500
10W (CRI80)			2700 ~ 6500 調光調色	15W (CRI80)			2700 ~ 6500 調光調色

TLMD-SI SD-5073-1

■□ / SMD 模組 / CRI90 / 鋁製品、鐵 / 100-240V

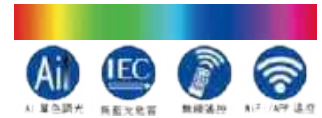

TLMD-SJ SD-5073-2

	尺寸 (mm)	光學角度	色溫 (K)
12W/15W	90×80×H160	25° 40° 60°	2200/2700 3000/3500 4000/5000/6500
20W (CRI80)			2700/3000 4000/5000
15W (CRI80)			2700 ~ 6500 調光調色

TLMD-SK SD-5073-3

	尺寸 (mm)	光學角度	色溫 (K)
12W/15W	90×65×H160	25° 40° 60°	2200/2700 3000/3500 4000/5000/6500
20W (CRI80)			2700/3000 4000/5000
15W (CRI80)			2700 ~ 6500 調光調色

TLMD-SM SD-5073-4

	尺寸 (mm)	光學角度	色溫 (K)
12W/15W	90×60×H160	140°	2200/2700 3000/3500 4000/5000/6500
15W			2700 ~ 6500 調光調色

■□ / SMD 模組 / CRI90 / 鋁製品、鐵 / 100-240V



§ SMD15W 以下可訂製 紅光 / 藍光 / 綠光，需另加價。

TLMR-AA
SD-5074-1



mini 款

TLMR-AB
SD-5074-2



專案款

TLMR-AC
SD-5074-3



熱門款

TLMR-AD
SD-5074-4



造型款



150
55 77

單位 mm



190
60 100

單位 mm



210
60 150

單位 mm



200
66 65

單位 mm

※ 此款不可加矩形光斑片
※ COB 款



※ 配件：四葉片



	顏色	材質
MR16 燈具	■ 黑 / □ 白	鋁製品 / 鐵
適用光源		



TLMR-CA
SD-5075-1



經典款



單位 mm

TLMR-CB
SD-5075-2



工業風款



單位 mm

TLMR-CD
SD-5075-3



層次款



單位 mm



	顏色	材質
MR16 燈具	■黑 / □白	鋁製品 / 鐵
適用光源		



TLAR-AA SD-5076-1



TLAR-AB SD-5076-2



TLAR-AC SD-5076-3



TLAR-AD SD-5076-4



	顏色	材質
AR111 燈具	■黑 / □白	鋁製品 / 鐵
適用光源		





TL27-AA SD-5077-1



	顏色	材質
E27 燈具	■黑 / □白	鐵 / 塑膠
適用光源		



軌道配件

軌道盒	10~12W 用	15~20W 用
	30~45W 用	免安用

吸頂盒			
	Φ96×40MM	Φ100×20MM	Φ140×40MM

加長桿						
	2CM 牙管	10CM	20CM	30CM	45CM	60CM



75mm



EBMD-CA SD-5078-1

□ / COB 模組 / CRI90 / 100-240V
鋁製品



	尺寸 (mm)	光學角度	色溫 (K)
7W	82×H133	20°	2700/3000/3500 4000/5000
10W			
15W		40°	2700 ~ 6500 調光調色
10W			



95mm

EBMD-CB SD-5078-2

□ / COB 模組 / CRI90 / 100-240V
鋁製品



	尺寸 (mm)	光學角度	色溫 (K)
7W	105×H130	20°	2700/3000/3500 4000/5000
10W			
15W		40°	2700 ~ 6500 調光調色
10W/15W			



120mm



EBMD-CC SD-5078-3

□ / COB 模組 / CRI90 / 100-240V
鋁製品



	尺寸 (mm)	光學角度	色溫 (K)
20W	131×H150	16°	2700/3000/3500 4000/5000
30W		28°	
15W		42°	2700 ~ 6500 調光調色



90mm



EBMD-CD SD-5078-4

□ / COB 模組 / CRI90 / 100-240V
鋁製品



	尺寸 (mm)	光學角度	色溫 (K)
7W	100×H35	20°	2700/3000/3500 4000/5000
10W			
15W		40°	2700 ~ 6500 調光調色
10W			

§ 此頁嵌燈可訂製全光譜 色溫 3000K / 4000K

§ 2700~6500K 調光調色晶片為 [bridgelux](http://www.bridgelux.com)。



120mm

EBMD-CE SD-5079-1

□ / COB 模組 / CRI90 / 鋁製品 / 100-240V



	尺寸 (mm)	光學角度	色溫 (K)	晶片廠牌
20W	130×H100	15° 30° 45°	2700/3000/3500/4000/5000	NICHIA
30W	130×H140		3000/3500/4000/5000	
45W			3000/4000	
15W	130×H100		2700 ~ 6500 調光調色	bridgelux.



355° 60°

120mm

EBMD-CF SD-5079-2

□ / COB 模組 / CRI90 / 鋁製品 / 100-240V



	尺寸 (mm)	光學角度	色溫 (K)	晶片廠牌
20W	135×H100	16°	2700/3000/3500/4000/5000	NICHIA
30W	135×H135	28°	3000/3500/4000/5000	
15W	135×H100	42°	2700 ~ 6500 調光調色	bridgelux.

§ 此頁嵌燈可訂製全光譜 15W —— 色溫 3000K / 4000K



93mm

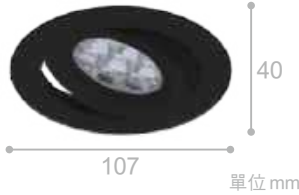

EBMD-SA SD-5080-1

□■ / SMD 模組 / CRI90 / 鋁製品 / 100-240V

	尺寸 (mm)	光學角度	色溫 (K)	晶片廠牌
7W	107×H40	25° 40° 60°	3000+RGB	NICHIA
10W			2200/2700 3000/3500 4000/5000/6500	
10W (CRI80)		2700 ~ 6500 調光調色		
		40° 60°		



93mm



EBMD-SB SD-5080-2

□■ / SMD 模組 / CRI90 / 鋁製品 / 100-240V

	尺寸 (mm)	光學角度	色溫 (K)	晶片廠牌
12W	107×H40	25° 40° 60°	2200/2700 3000/3500 4000/5000/6500	NICHIA
15W			2700/3000 4000/5000	
20W (CRI80)	107×H65			
15W (CRI80)		40° 60°		



※ 配件：遮光罩



93mm

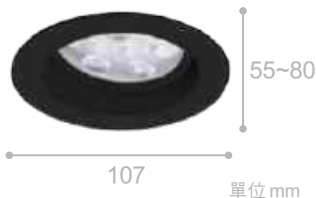

EBMD-SC SD-5080-3

□■ / SMD 模組 / CRI90 / 鋁製品 / 100-240V

	尺寸 (mm)	光學角度	色溫 (K)	晶片廠牌
12W	107×H55	25° 40° 60°	2200/2700 3000/3500 4000/5000/6500	NICHIA
15W	107×H80		2700/3000 4000/5000	
20W (CRI80)			2700 ~ 6500 調光調色	
15W (CRI80)	40° 60°			



※ 配件：遮光罩



§ SMD15W 以下可訂製 紅光 / 藍光 / 綠光，需另加價。



93mm



單位 mm

EBMD-SD SD-5081-1

□■ / SMD 模組 / CRI80 / 鋁製品 / 100-240V

	尺寸 (mm)	光學角度	色溫 (K)	晶片廠牌
7W	107×H55	6°	2700/3000 4000/5000	NICHIA



93mm



單位 mm

EBMD-PA SD-5081-2

□■ / SMD 模組 / CRI90 / 鋁製品 / 100-240V

	尺寸 (mm)	光學角度	色溫 (K)	晶片廠牌
12W	107×H40	140°	2200/2700 3000/3500 4000/5000/6500 2700 ~ 6500 調光調色	NICHIA
15W	107×H65			
15W				



93mm



單位 mm

EBMD-SE SD-5081-3

□■ / SMD 模組 / CRI80 / 鋁製品、鐵 / 100-240V

	尺寸 (mm)	光學角度	色溫 (K)	晶片廠牌
30W	115×H80	25° 40° 60°	2700/3000 4000/5000 2700 ~ 6500 調光調色	NICHIA
30W		40° 60°		



§ SMD15W 以下可訂製 紅光 / 藍光 / 綠光，需另加價。



18mm

EBMD-AA SD-5082-1

□■ / SMD 模組 / CRI90 / 鋁製品 / DC12V



	尺寸 (mm)	光學角度	色溫 (K)	晶片廠牌
1W	22×H28	30°	2200/2700 3000/3500 4000/5000/6500	



35mm

EBMD-AB SD-5082-2

□■ / SMD 模組 / CRI90 / 鋁製品 / 100-240V



	尺寸 (mm)	光學角度	色溫 (K)	晶片廠牌
1W	45×H20	60°	2200/2700 3000/3500 4000/5000/6500	



35mm



45mm

EBMD-AC SD-5082-3

□■ / SMD 模組 / CRI90 / 鋁製品 / 100-240V



	尺寸 (mm)	光學角度	色溫 (K)	晶片廠牌
1W	53×H20	60°	2200/2700 3000/3500 4000/5000/6500	



45mm



43mm

EBMD-AD SD-5082-4

□■ / SMD 模組 / CRI90 / 鋁製品 / 100-240V



	尺寸 (mm)	光學角度	色溫 (K)	晶片廠牌
5W	50×H20	40°	2200/2700 3000/3500 4000/5000/6500	
		60°		



§ SMD 可訂製 紅光 / 藍光 / 綠光，需另加價。



58mm

EBMD-AE SD-5083-1

□■ / SMD 模組 / CRI90 / 鋁製品 / 100-240V



	尺寸 (mm)	光學角度	色溫 (K)	晶片廠牌
5W	70×H20	140°	2200/2700 3000/3500 4000/5000/6500	NICHIA



58mm

EBMD-AF SD-5083-2

□■ / SMD 模組 / CRI90 / 鋁製品 / 100-240V



	尺寸 (mm)	光學角度	色溫 (K)	晶片廠牌
5W	72×H20	40° 60°	2200/2700 3000/3500 4000/5000/6500	NICHIA



超薄款



60mm

EBMD-AG SD-5083-3

□■ / COB 模組 / CRI90 / 鋁製品 / 100-240V



	尺寸 (mm)	光學角度	色溫 (K)	晶片廠牌
7W	72×H26	15°	2700/3000/3500 4000/5000	NICHIA
7W		38°	2700 ~ 6500 調光調色	bridgelux



§ SMD 可訂製 紅光 / 藍光 / 綠光，需另加價。

EBMR-AA

SD-5084-1

熱銷 / 細框款



75mm



EBMR-AB

SD-5084-2

細框款



85mm



	顏色	材質
MR16 燈具	■黑 / □白	鋁製品
適用光源		



EBMR-AC

SD-5084-3

細框快拆款



85mm



EBMR-AD

SD-5084-4

細框款



93mm

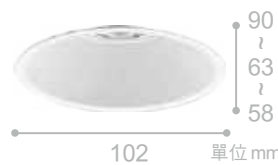

EBMR-BA

SD-5085-1

經典款



93mm

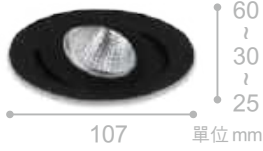

EBMR-BB

SD-5085-2

內縮遮光款



93mm

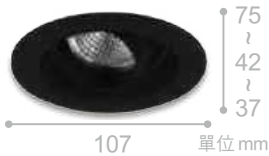

EBMR-BC

SD-5085-3

雙框調角款



93mm



EBMR-BD

SD-5085-4

無邊款



95mm



無邊專用刀具



EBMR-BE

SD-5085-5

無邊炮口款



95mm



	顏色	材質
MR16 燈具	■黑 / □白	鋁製品
適用光源		



EBMR-CA

SD-5086-1

平口款



EBMR-CB

SD-5086-2

斜口款



	顏色	材質
MR16 燈具	□白 + 鏡面反射罩	鋁製品
適用光源		



EBMD-CG SD-5086-3

□ / COB 模組 / CRI90 / 100-240V
鋁製品



EBMD-CH SD-5086-4

□ / COB 模組 / CRI90 / 100-240V
鋁製品



	尺寸 (mm)	光學角度	色溫 (K)
7W	66 × H65	20°	2700/3000/3500 4000/5000
10W			
10W		40°	2700 ~ 6500 調光調色

	尺寸 (mm)	光學角度	色溫 (K)
10W	86 × H80	20°	2700/3000/3500 4000/5000
15W			
20W		40°	2700 ~ 6500 調光調色

§ 此頁嵌燈可訂製全光譜 色溫 3000K / 4000K

§ 2700~6500K 調光調色晶片為 *bridgelux*。

EBMR-DA

SD-5087-1

正圓快拆款

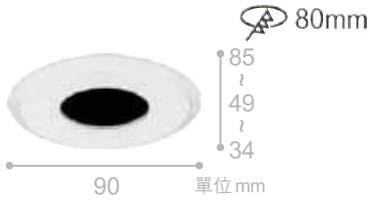

EBMR-DB

SD-5087-2

橢圓快拆款

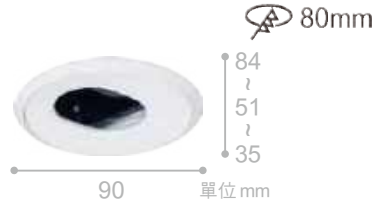

EBMR-DC

SD-5087-3

正圓款

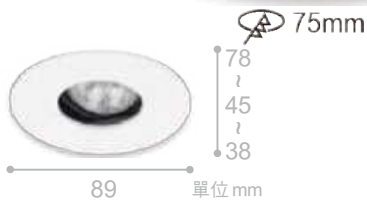

EBMR-DD

SD-5087-4

橢圓款

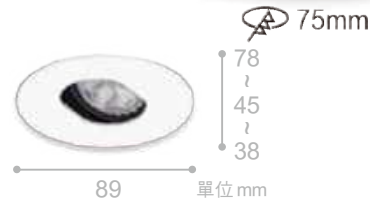

EBMR-DE

SD-5087-5

防潮款 (玻璃面)



75mm



	顏色	材質
MR16 燈具	□白	鋁製品
適用光源		



EBMR-EA

SD-5088-1

快拆款

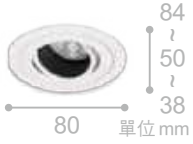

70mm



EBMR-EB

SD-5088-2

蜂巢快拆款

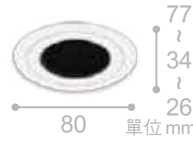

70mm



EBMR-EC

SD-5088-3

熱銷 / 快拆款

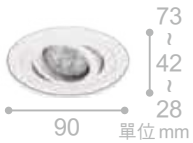

80mm



EBMR-ED

SD-5088-4

快拆款

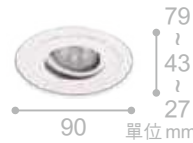

80mm



EBMR-EE

SD-5088-5

內縮防眩款

60mm

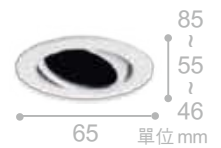

	顏色	材質
MR16 燈具	□白 / ■仿不鏽鋼銀	鋁製品
適用光源		



EBMR-FA

SD-5089-1

□白色 / ■黑色



75x75mm



85

90
84
60
單位 mm

EBMR-GA

SD-5089-2

□白色



75mm

EBMR-GB

SD-5089-3

■內黑外白



66
37
22
85
單位 mm

※ 配件：遮光罩



EBMR-HA

SD-5089-4

□白色 / ■真空電鍍鏡面



75mm



113
84
74
82
單位 mm



	顏色	材質
MR16 燈具	依圖示	鋁製品
適用光源		



EBAR-AA

SD-5090-1

細框款



150mm

※ 配件：遮光罩



EBAR-AB

SD-5090-2



150mm

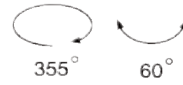

EBAR-BA

SD-5090-3



130mm

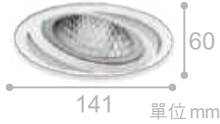

EBAR-BB

SD-5090-4

快拆款



150mm

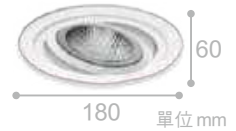

	顏色	材質
AR111 燈具	□白	鋁製品
適用光源		



EBAR-CA
SD-5091-1

十字格款



EBAR-CB
SD-5091-2



EBAR-CC
SD-5091-3

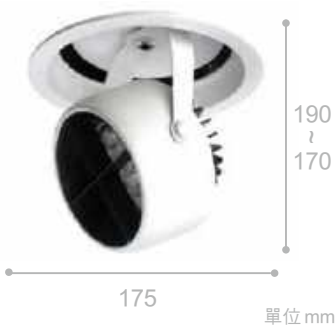

	顏色	材質
AR111 燈具	□白	鋁製品
適用光源		



EBMD-FA
SD-5092-1

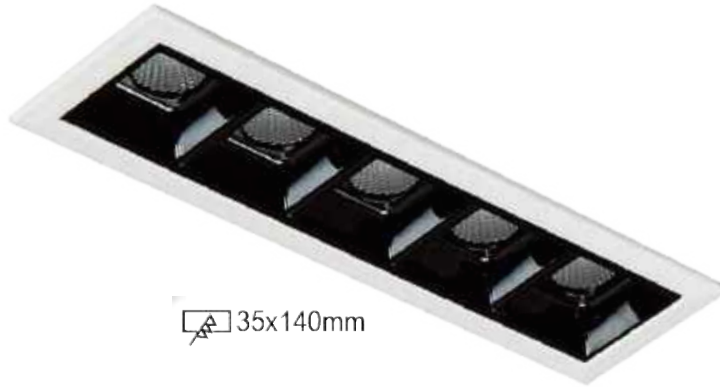

35x140mm

EBMD-FB
SD-5092-2



35x272mm

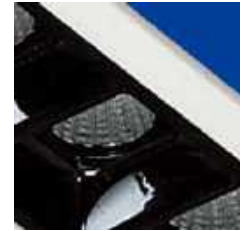

EBMD-FC
SD-5092-3



35x405mm

■ / SMD 模組 / CRI90 / 鋁製品、塑膠 / 100-240V



	尺寸 (mm)	光學角度	色溫 (K)	晶片廠牌
8W	147×45×H50 mm	40° 60°	2200/2700/3000/3500 4000/5000/6500	
14W	280×45×H50 mm			
18W	412×45×H50 mm			

§ SMD 可訂製 紅光 / 藍光 / 綠光，需另加價。

EBMD-DA
SD-5093-1



60x60mm

EBMD-DB
SD-5093-2



60x120mm



※ 三燈擺置

■ / COB 模組 / CRI90 / 鋁製品、鐵 / 100-240V



	尺寸 (mm)	光學角度	色溫 (K)	晶片廠牌
7W	單燈 59×59×H56 mm 雙燈 59×119×H56 mm	40°	2700/3000/3500 4000/5000	NICHIA
7W		60°	2700 ~ 6500 調光調色	bridgelux.



※ 一字四燈擺置

EBMD-EA
SD-5093-3



86x86mm

EBMD-EB
SD-5093-4



86x171mm

■ / COB 模組 / CRI90 / 鋁製品、鐵 / 100-240V



	尺寸 (mm)	光學角度	色溫 (K)	晶片廠牌
7W	單燈 85×85×H140 mm 雙燈 85×170×H140mm	40°	2700/3000/3500 4000/5000	NICHIA
10W		60°	2700 ~ 6500 調光調色	bridgelux.
15W				
15W				



※ 田字四燈擺置

EBMD-HA
SD-5094-1



115x115mm

EBMD-HB
SD-5094-2



115x219mm

EBMD-HC
SD-5094-3



115x323mm

■ / SMD 模組 / CRI90 / 鋁製品、鐵 / 100-240V



綠藍網 AI 藍光調光 無藍光危害 無線遙控 AI / APP 遙控

尺寸 (mm)		光學角度	色溫 (K)	晶片廠牌
7W			3000+RGB	
10W	單燈 114×114×H90 雙燈 114×218×H90 三燈 114×322×H90	25° 40° 60°	2200/2700/3000/3500 4000/5000/6500	
10W (CRI80)		40° 60°	2700 ~ 6500 調光調色	

§ SMD 可訂製 紅光 / 藍光 / 綠光，需另加價。

EBMD-GA
SD-5095-1



115x115mm

EBMD-GB
SD-5095-2



115x219mm

EBMD-GC
SD-5095-3



115x323mm



	顏色	材質
SMD 模組燈具	■黑 / □白 (訂製品)	鋁製品 / 鐵
適用光源		



EBMD-IA
SD-5096-1



151x151mm

EBMD-IB
SD-5096-2



151x301mm

■ / COB 模組 / CRI90 / 鋁製品、鐵 / 100-240V



尺寸 (mm)		光學角度	色溫 (K)	晶片廠牌
20W	單燈 150×150×H140 雙燈 150×300×H140	15° 30° 45°	2700/3000/3500/4000/5000	
30W			3000/3500/4000/5000	
45W			3000/4000	
15W			2700 ~ 6500 調光調色	

EBMD-JA

SD-5097-1



93x121mm



EBMD-JB

SD-5097-2



93x236mm



■ / COB 模組 / CRI90 / 鋁製品 / 100-240V



	光源尺寸 (mm)	光學角度	色溫 (K)	晶片廠牌
10W	單燈 92×120×H43mm 雙燈 92×235×H43mm	20° 40°	2700/3000/3500 4000/5000	
15W				
10W			2700 ~ 6500 調光調色	

細邊框款

EBMR-HA
SD-5098-1



100x100mm

EBMR-HB
SD-5098-2



100x200mm

EBMR-HC
SD-5098-3



100x270mm



	顏色	尺寸 (mm)	材質
MR16 燈具	□白 / ■黑	單燈 112×112×H85 雙燈 112×212×H85 三燈 112×282×H85	鋁製品

適用光源



細邊框款

EBAR-HA
SD-5099-1



165x165mm

EBAR-HB
SD-5099-2



165x310mm

EBAR-HC
SD-5099-3



165x455mm



	顏色	尺寸 (mm)	材質
AR111 燈具	□白 / ■黑	單燈 175×175×H60 雙燈 175×325×H60 三燈 175×470×H60	鋁製品

適用光源



EBAR-IA
SD-5100-1



160x160mm

EBAR-IB
SD-5100-2



160x310mm

EBAR-IC
SD-5100-3



160x455mm

EBAR-ID
SD-5100-4



310x310mm



	顏色	尺寸 (mm)	材質
AR111 燈具	■ 內黑框白	單燈 180×180×H90 雙燈 180×330×H90 三燈 180×473×H90 田字四燈 333×333×H90	鋁製品 / 鐵

適用光源



EBAR-JA

SD-5101-1



161x161mm

EBAR-JB

SD-5101-2



161x311mm

EBAR-JC

SD-5101-3



161x461mm

EBAR-JD

SD-5101-4



311x311mm



	顏色	尺寸 (mm)	材質
AR111 燈具	■黑 / □白 (訂製品)	單燈 160×160×H90 雙燈 160×310×H90 三燈 160×460×H90 田字四燈 310×310×H90	鐵

適用光源



EBMR-IA
SD-5102-1



120x120mm

EBMR-IB
SD-5102-2



120x220mm

EBMR-IC
SD-5102-3



120x325mm



	顏色	尺寸 (mm)	材質
MR16 燈具	■內黑框白	單燈 142×142×H90 雙燈 142×246×H90 三燈 142×350×H90	鐵 / 鋁

適用光源



EBMR-JA

SD-5103-1



115x115mm

EBMR-JB

SD-5103-2



115x219mm

EBMR-JC

SD-5103-3



115x323mm



	顏色	尺寸 (mm)	材質
MR16 燈具	■黑 / □白 (訂製品)	單燈 114×114×H90 雙燈 114×218×H90 三燈 114×322×H90	鐵

適用光源



EBMR-KA
SD-5104-1



85x85mm

EBMR-KB
SD-5104-2



85x165mm

EBMR-KC
SD-5104-3



85x245mm



	顏色	尺寸 (mm)	材質
MR16 燈具	□白 / ■黑	單燈 103×103×H84 雙燈 103×180×H84 三燈 103×258×H84	鋁、鐵

適用光源



EBMR-LA
SD-5105-1



86x86mm

EBMR-LB
SD-5105-2



86x171mm

EBMR-LC
SD-5105-3



86x251mm



	顏色	尺寸 (mm)	材質
MR16 燈具	■ 黑	單燈 85×85×H80 雙燈 85×170×H80 三燈 85×250×H80	鋁、鐵

適用光源



EBMD-PB**SD-5106-1**

超薄擴散板款



120mm

□ / SMD 模組 / CRI90 / 鋁製品 / 100-240V

EBMD-PC**SD-5106-2**

超薄擴散板款



150mm



	尺寸 (mm)	光學角度	色溫 (K)	晶片廠牌
12W	嵌入 120 : 143×H20 嵌入 150 : 173×H20	140°	2200/2700/3000/3500 4000/5000/6500	
15W	嵌入 120 : 143×H20 嵌入 150 : 173×H20			
15W	嵌入 120 : 143×H20 嵌入 150 : 173×H20		2700 ~ 6500 調光調色	

EBMD-PH SD-5106-3 擴散板款

93mm

EBMD-PJ SD-5106-5

150mm

EBMD-PI SD-5106-4 擴散板款

120mm

□ / SMD 模組 / CRI90 / 鋁製品 / 100-240V



	尺寸 (mm)	光學角度	色溫 (K)	晶片廠牌
10W	嵌入 93 : 105×H50	140°	2200/2700/3000/3500 4000/5000/6500	
12W	嵌入 120 : 130×H45 嵌入 150 : 160×H55			
15W	嵌入 120 : 130×H70 嵌入 150 : 160×H55			
24W	嵌入 120 : 130×H70 嵌入 150 : 160×H80			
32W	嵌入 120 : 130×H100 嵌入 150 : 160×H100			
10W (CRI80)	嵌入 93 : 105×H50		2700 ~ 6500 調光調色	
15W	嵌入 120 : 130×H70 嵌入 150 : 160×H55			
30W (CRI80)	嵌入 120 : 130×H100 嵌入 150 : 160×H100			

§ SMD 可訂製 紅光 / 藍光 / 綠光，需另加價。

EBMD-PD**SD-5107-1**

玻璃款



120mm

EBMD-PF**SD-5107-3**

擴散板款



150mm

EBMD-PE**SD-5107-2**

玻璃款



150mm

EBMD-PG**SD-5107-4**

玻璃款



180mm

□ / SMD 模組 / CRI90 / 鋁製品 / 100-240V



AI 藍光調光

無線光感

無線通訊

AI / APP 遙控

	尺寸 (mm)	光學角度	色溫 (K)	晶片廠牌
12W	嵌入 120 : 135×H50 嵌入 150 : 170×H50 嵌入 180 : 195×H60	140°	2200/2700/3000/3500 4000/5000/6500	
15W	嵌入 120 : 135×H75 嵌入 150 : 170×H50 嵌入 180 : 195×H60			
24W	嵌入 120 : 135×H75 嵌入 150 : 170×H75 嵌入 180 : 195×H60			
32W	嵌入 150 : 170×H100 嵌入 180 : 195×H60			
50W	嵌入 180 : 195×H100			
15W	嵌入 120 : 135×H75 嵌入 150 : 170×H50 嵌入 180 : 195×H60			
30W (CRI80)	嵌入 150 : 170×H100 嵌入 180 : 195×H60			

§ SMD 可訂製 紅光 / 藍光 / 綠光，需另加價。

EBMD-PL**SD-5108-1**

擴散板款



120mm

EBMD-PM**SD-5108-2**

擴散板款



150mm

EBMD-PN**SD-5108-3**

擴散板款



165mm

□ / SMD 模組 / CRI90 / 鋁製品 / 100-240V



	尺寸 (mm)	光學角度	色溫 (K)	晶片廠牌
12W 15W	嵌入 120 : 140×H40 嵌入 150 : 175×H40 嵌入 165 : 190×H40	140°	2200/2700/3000/3500 4000/5000/6500	
24W	嵌入 120 : 140×H40 嵌入 150 : 175×H40 嵌入 165 : 190×H40			
32W	嵌入 120 : 140×H95 嵌入 150 : 175×H95 嵌入 165 : 190×H95			
15W	嵌入 120 : 140×H40 嵌入 150 : 175×H40 嵌入 165 : 190×H40		2700 ~ 6500 調光調色	
20W (CRI80)	嵌入 120 : 140×H40 嵌入 150 : 175×H40 嵌入 165 : 190×H40			
30W (CRI80)	嵌入 120 : 140×H95 嵌入 150 : 175×H95 嵌入 165 : 190×H95			

§ SMD 可訂製 紅光 / 藍光 / 綠光，需另加價。

EBMD-PK**SD-5109-1**

擴散板款



93mm

EBMD-PO**SD-5109-2**

擴散板款



200mm

215mm

EBMD-PP**SD-5109-3**

擴散板款



245mm

□ / SMD 模組 / CRI90 / 鋁製品 / 100-240V



	尺寸 (mm)	光學角度	色溫 (K)	晶片廠牌
12W	嵌入 93 : 110×H30 嵌入 200/215 : 235×H50 嵌入 245 : 270×H50	140°	2200/2700/3000/3500 4000/5000/6500	
15W	嵌入 93 : 110×H30 嵌入 200/215 : 235×H50 嵌入 245 : 270×H50			
24W	嵌入 93 : 110×H55 嵌入 200/215 : 235×H50 嵌入 245 : 270×H50			
32W	嵌入 93 : 110×H80 嵌入 200/215 : 235×H50 嵌入 245 : 270×H50			
50W	嵌入 200/215 : 235×H75 嵌入 245 : 270×H75			
85W	嵌入 200/215 : 235×H95 嵌入 245 : 270×H95			
15W	嵌入 93 : 110×H30 嵌入 200/215 : 140×H40 嵌入 245 : 175×H40			
20W 30W (CRI80)	嵌入 200/215 : 235×H50 嵌入 245 : 270×H50			

§ SMD 可訂製 紅光 / 藍光 / 綠光，需另加價。

CLMD-AA
SD-5110-1

※COB 款
7W
10W
15W
10W 調光調色



CLMD-AB
SD-5110-2

※七燈款
7W 3000K+RGB
10W
10W 調光調色



CLMD-AC
SD-5110-3



※九燈、十二燈款
12W
15W
20W
15W 調光調色



CLMD-AD
SD-5110-4



※防眩款
12W
15W
20W
15W 調光調色

CLMD-AE
SD-5110-5



※泛光款
12W
15W
15W 調光調色



■□ / COB、SMD 模組 / CRI90 / 鋁製品、鐵 / 100-240V



	尺寸 (mm)	光學角度	色溫 (K)	晶片廠牌
7W 10W 15W COB 模組	115×H160	15° 30° 60°	2700/3000/3500/4000/5000	NICHIA
10W COB 模組			2700 ~ 6500 調光調色	bridgelux
7W		25° 40° 60°	3000+RGB	NICHIA
10W 12W 15W		25° 40° 60° 140°	2200/2700/3000/3500 4000/5000/6500	
20W (CRI80)		25° 40° 60°	2700/3000/4000/5000	
10W (CRI80)		40° 60°	2700 ~ 6500 調光調色	
15W (CRI80)		40° 60° 140°		

§ SMD15W 以下可訂製 紅光 / 藍光 / 綠光，需另加價。

CLAR-AA
SD-5111-1

A 款



CLAR-AB
SD-5111-2

B 款



	顏色	尺寸 (mm)	材質
AR111 燈具	□白 / ■黑	A 款 :140×H155 B 款 :190×H190	鋁、鐵

通用光源



CLMD-BA **SD-5111-3**

■□ / SMD 模組 / CRI90 **NICHIA**
鋁製品、鐵、擴散板 / 100-240V



CLMD-BB **SD-5111-4**

■□ / SMD 模組 / CRI90
鐵、PC 罩 / 100-240V



	尺寸 (mm)	光學角度	色溫 (K)
12W 15W 24W 30W	190×H190	140°	2200/2700/3000/3500 4000/5000/6500
15W 30W (CRI80)			2700 ~ 6500 調光調色

	尺寸 (mm)	光學角度	色溫 (K)
30W 50W	271×H220	140°	2200/2700/3000/3500 4000/5000/6500
45W 開放式 (CRI80)		25° 40° 60°	2700/3000/4000/5000

§ SMD15W 以下可訂製 紅光 / 藍光 / 綠光，需另加價。

§ SMD 可訂製 紅光 / 藍光 / 綠光，需另加價。

CLMD-CA

SD-5112-1

袖珍 mini 款



CLMD-CB

SD-5112-2

熱銷款



■□ / SMD 模組 / CRI90 / 鋁製品、PC 罩 / 100-240V



	尺寸 (mm)	光學角度	色溫 (K)	晶片廠牌
5W 10W	mini 款 :86×H60	140°	2200/2700/3000/3500 4000/5000/6500	NICHIA
10W (CRI80)			2700 ~ 6500 調光調色	
12W 15W 20W 32W	170×H100		2200/2700/3000/3500 4000/5000/6500	
15W 30W (CRI80)			2700 ~ 6500 調光調色	



CLMD-CC SD-5112-3

■□ / COB 模組 / CRI90 / 鋁製品 / 100-240V



	光源尺寸 (mm)	光學角度	色溫 (K)	晶片廠牌
10W 15W	92×H62 mm	20° 40°	2700/3000/3500 4000/5000	NICHIA
10W 15W			3000/4000 (全光譜)	
10W			2700 ~ 6500 調光調色	bridgelux.



CLMD-DA SD-5113-1

■□ / COB 模組 / CRI90 / 鋁製品 / 100-240V



	尺寸 (mm)	光學角度	色溫 (K)	晶片廠牌
20W	95×H175	15°	2700/3000/3500 4000/5000	
30W		30°		
		45°	3000/3500 4000/5000	

CLMD-EA SD-5113-2

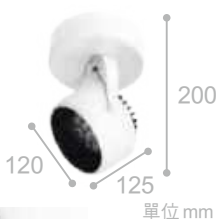

※ 十字格



CLMD-EB SD-5113-3



	顏色	材質
AR111 燈具	□白 / ■黑	鋁、鐵

適用光源



吸頂式盒燈

CLMD-FA
SD-5114-1CLMD-FB
SD-5114-2

■ / COB 模組 / CRI90 / 鋁製品 / 100-240V



	尺寸 (mm)	光學角度	色溫 (K)	晶片廠牌
10W	單燈 92×120×H43mm 雙燈 92×235×H43mm	20° 40°	2700/3000/3500 4000/5000	NICHIA
15W			2700 ~ 6500 調光調色	bridgelux.
10W				

CLMR-BA
SD-5115-1



CLAR-BA
SD-5115-3



CLMR-BB
SD-5115-2



CLAR-BB
SD-5115-4



■ / □ (訂製品)

MR16 燈具	尺寸 (mm)	材質
單燈	114×114×H130	鋼板烤漆
雙燈	114×218×H130	
適用光源		



■ / □ (訂製品)

AR111 燈具	尺寸 (mm)	材質
單燈	160×160×H160	鋼板烤漆
雙燈	160×310×H160	
適用光源		



SSMD-NA SD-5116-1



SSMD-AA SD-5116-3



SMD / CRI90 / 銅軟板、3M 背膠



	尺寸 (mm)	燈數	裁剪 (mm)	光學角度	驅動電壓	色溫 (K)	晶片廠牌
SSMD-NA 15W / M (SMD3030)	8×2	60 燈 /1M	100	120°	DC24V	3000/4000	NICHIA
SSMD-NB 20W / M (SMD3030)	10×2	36 燈 /59CM	49			2200/2700 3000/3500 4000/5000/6500	
SSMD-AA 12W / M (SMD2835)	5×2	120 燈 /1M	50		DC24V (可訂製 12V)	2700/3000/3500 4000/5000/6500	bridgelux

SSMD-NB SD-5116-2



SSMD-AB
SD-5117-1



SSMD-AC
SD-5117-2



SMD / CRI90 / 銅軟板、3M 背膠



	尺寸 (mm)	燈數 (每米)	裁剪 (mm)	光學角度	驅動電壓	色溫 (K)	晶片廠牌
SSMD-AB 12W / M (SMD2835)	8×2	192 燈 (黃 96/ 白 96)	62	120°	DC24V	2700~6500K 調光調色	bridgelux
SSMD-AC 12W / M	8×2	120 燈	50			RGB	



ALMD-AA

SD-5118-1



※ 限制 5mm 細版軟燈帶

尺寸 (mm)	光學角度	光源	材質
L 訂製 × W8 × H9	120°	SMD	鋁 / 霧 PC 罩

ALMD-AB

SD-5118-2

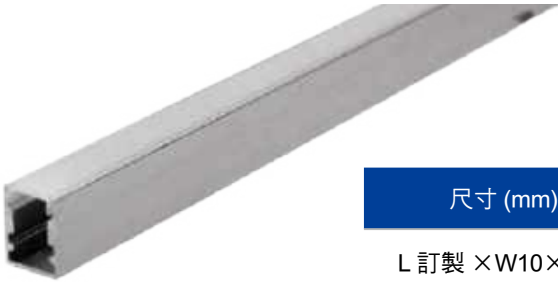

※ 限制 5mm 細版軟燈帶

尺寸 (mm)	光學角度	光源	材質
L 訂製 × W10 × H13	120°	SMD	鋁 / 霧 PC 罩

ALMD-AC

SD-5118-3

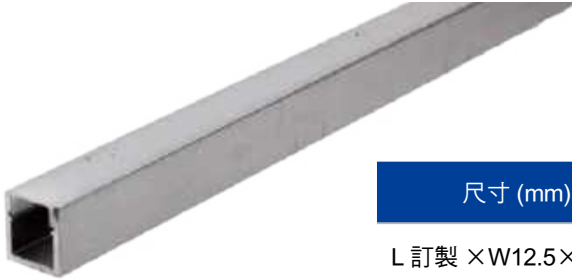

※ 限制 8mm 軟燈帶
 ※ 可加裝觸碰調光開關，限 40W

尺寸 (mm)	光學角度	光源	材質
L 訂製 × W12.5 × H13.5	120°	SMD	鋁 / 霧 PC 罩

ALMD-AD

SD-5118-4



※ 限制 10mm 細版軟燈帶
 ※ 可加裝觸碰調光開關，限 40W

尺寸 (mm)	光學角度	光源	材質
L 訂製 × W14 × H14	120°	SMD	鋁 / 霧 PC 罩

※ 鋁條最長為 300CM，可依現場要求客製。軟燈帶參考 116-117 頁。

ALMD-AE SD-5119-1



尺寸 (mm)	光學角度	光源	材質
L 訂製 × W13 × H13	45°	SMD	鋁 / 霧 PC 罩

ALMD-AF SD-5119-2



尺寸 (mm)	光學角度	光源	材質
L 訂製 × W16 × H16	45°	SMD	鋁 / 霧 PC 罩

ALMD-AG SD-5119-3



※ 可加裝觸碰調光開關，限 40W

尺寸 (mm)	光學角度	光源	材質
L 訂製 × W17 × H12	120°	SMD	鋁 / 霧 PC 罩

ALMD-AH SD-5119-4



尺寸 (mm)	光學角度	光源	材質
L 訂製 × W10 × H16	120°	SMD	鋁 / X 罩

※ 鋁條最長為 300CM，可依現場要求客製。軟燈帶參考 116-117 頁。

ALMD-BA SD-5119-5



SMD3014 / CRI90 / 壓克力、背膠、固定夾

	尺寸 (mm)	光學角度	驅動電壓	色溫 (K)	壓克力罩
12W / M	20 × 15	120°	110V/220V	3000/4000/6000	霧罩 / 透明罩

ALMD-BA

SD-5120-1

窄版下照 140°

※18W

ALMD-BB

SD-5120-2

寬版下照 140°

※18W / 36W

ALMD-BC

SD-5120-3

270° 發光

※36W

■□ / SMD 模組 / CRI90 / 鋁製品、PC 罩 / 100-240V



	尺寸 (mm)	光學角度	色溫 (K)	晶片廠牌
18W	28×H50×1200 50×H50×1200	140°	2700/3000/3500/4000 5000/6500	
36W	50×H50×1200 38×H60×1200			
18W	28×H50×1200 50×H50×1200		2700 ~ 6500 調光調色	
36W	50×H50×1200 38×H60×1200			



ALAR-AB
SD-5121-2

ALAR-AA
SD-5121-1



	尺寸 (mm)	顏色	材質	安裝方式
AR111 燈具	單燈 :200×200×50 雙燈 :200×320×50	■銀 / ■黑	鋁、鐵	吊索

適用光源



室內型 梯腳燈

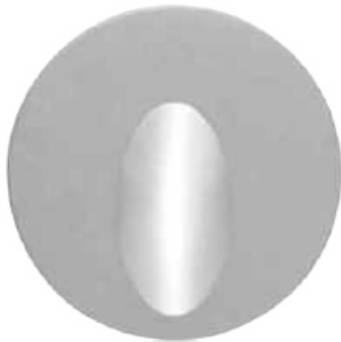

45mm

KKMD-AA SD-5122-1

■ / SMD 模組 / CRI80 / 鋁製品 / 100-240V



	尺寸 (mm)	光學角度	色溫 (K)	晶片廠牌
3W	55×H30 mm	X	2700/3000 4000/5000	



45mm

KKMD-AB SD-5122-2

■ / SMD 模組 / CRI80 / 鋁製品 / 100-240V



	尺寸 (mm)	光學角度	色溫 (K)	晶片廠牌
3W	55×H30 mm	X	2700/3000 4000/5000	



30x70mm

KKMD-AC SD-5122-3

■ / SMD 模組 / CRI80 / 鋁製品 / 100-240V



	尺寸 (mm)	光學角度	色溫 (K)	晶片廠牌
3W	35×H88×40 mm	X	2700/3000 4000/5000	



LWMD-AA SD-5123-1

■ / SMD 模組 / CRI90 / 鋁製品 / 24V 48V 100-240V

	尺寸 (mm)	光學角度	色溫 (K)	晶片廠牌
10W (DC24V)	74×117×H332 mm	25° 40° 60°	2700/3000/4000/5000	
10W (DC48V)			2200/2700/3000/3500	
10W (100-240V)			4000/5000/6500	

戶外防水型 梯腳燈



KKMD-BA SD-5123-2

□ ■ / SMD 模組 / CRI90 / 鋁製品 / 12V 24V 100-240V

	尺寸 (mm)	光學角度	色溫 (K)	晶片廠牌
4W (12V)	108×H76×50 mm	X	2700/3000/4000/5000	
4W (24V)			2200/2700/3000/3500	
4W (100-240V)			4000/5000/6500	

§ SMD 可訂製 紅光 / 藍光 / 綠光，需另加價。

室內型 (可訂製防水型)

SLMD-AA
SD-5124-1**SLMD-AB**
SD-5124-2

依照圖示 / SMD 模組 / CRI90 / 鋁製品、玻璃 / 100-240V



新藍光電器

	光源尺寸 (mm)	光學角度	色溫 (K)	晶片廠牌
150W	270×H300 mm	60° 90°	2200/2700/3000/3500 4000/5000/6500	
200W	加罩 400×H450 mm	加罩 60° 90° 120°		

防水型

**SLMD-BA** SD-5124-3

■黑 / SMD 模組 / CRI90 / 鋁製品、PMMA / 100-240V



新藍光電器

	光源尺寸 (mm)	光學角度	色溫 (K)	晶片廠牌
40W	180×80×H250 mm	90° 60X150° (訂製品)	2200/2700/3000/3500 4000/5000/6500	

§ 此頁商品保固為一年。

防水型



SLMD-CA SD-5125-1

■ / COB 模組 / CRI90 / 鋁、鐵 / 100-240V



	尺寸 (mm)	光學角度	色溫 (K)	晶片廠牌
20W	180×140×100	120°	2700/3000/3500 4000/5000	NICHIA
30W	228×188×130		3000/3500 4000/5000	



SLMD-CB SD-5125-2

■ / SMD 模組 / CRI90 / 鋁、鐵 / 100-240V



	尺寸 (mm)	光學角度	色溫 (K)	晶片廠牌
15W	180×140×100	25°	2200/2700 3000/3500 4000/5000/6500	NICHIA
24W (CRI80)		40°	2700/3000 4000/5000	
36W (CRI80)	60°			
	228×188×130			



SLMD-CC SD-5125-3

■ / SMD 模組 / CRI90 / 鋁、鐵 / 100-240V



	尺寸 (mm)	光學角度	色溫 (K)	晶片廠牌
55W	228×188×130	120°	2200/2700 3000/3500 4000/5000/6500	NICHIA
100W	285×230×130			

OUTDOOR SPOT LIGHTING (SLMD)

§ 此頁商品保固為一年。







CM Smart

新世代 **AI** 智能照明系統



智能系統介紹



CM Smart

新世代AI智能照明系統
讓家的幸福沒有極限